

Power and Grounding for Audio and Video Systems

A White Paper for the Real World – International Version

Jim Brown
Audio Systems Group, Inc.

Considerable confusion seems to surround power and grounding for audio and audio/video systems. This "White Paper" is an attempt to cut through the confusion and set out a collection of good engineering practice that is both safe and effective while not requiring specialized or costly measures to avoid hum, buzz, noise, or RF interference. The author believes that the recommendations and practices outlined herein are safe, and that they conform to building codes in most of the world. The author is an electrical engineer by training and an audio systems consultant by profession, but is not a registered Professional Engineer. No warranty is made or implied as to the extent to which these practices conform to local codes or regulations. Qualified professional engineers and electrical contractors should design and install all electrical systems.

While this tutorial was initially written to describe practices and legal requirements in North America where the author lives and works, the laws of physics don't change as we cross the Atlantic. Indeed, the international differences between power systems are limited to the line voltages (100, 120 or 230 volts), the frequency (50 or 60 Hz), and details of how neutrals and grounds are handled. When reading this paper, the reader should substitute the line voltage and frequency of his or her own country for those in the drawings, and see the Appendix for a summary of worldwide differences and practice. In general, we can say that:

- ♦ All national power systems provide AC power.
- ♦ Virtually all power systems in the developed world have one side of the power system bonded to earth.
- ♦ The power *frequency* is 60Hz in most the Americas, part of Japan, and a few other countries having strong ties to America or Japan. The rest of the world runs on 50 Hz power.
- ♦ The voltage at power outlets and residential lighting is 220-240V for countries that use 50 Hz power and 120V for countries that use 60 Hz power, except that Japan operates on 100V.
- ♦ Countries that operate on 100-120V at outlets also utilize 200-240V for high power equipment and appliances.
- ♦ In all countries, 3-phase power is available for large users. Where 230V is standard, the 3-phase power is 400V; where 120V is used, 3-phase power is distributed at 208V, 277 volts, and 480 volts.

230V 50 Hz systems have two advantages over 120V 60 Hz systems. First, they produce less than half the magnetic field interference. Second, voltage drop in the supply conductors is half as great for conductors of equal size. 100V and 120V systems have one advantage over the higher voltage systems – leakage current is roughly half as much for the lower voltage systems. More about these issues later.

INTERNATIONAL POWER SUPPLIES

Many products are designed and built so that they can be used anywhere in the world. Nearly all electronic equipment includes circuitry called a *power supply* (also called a *power supply unit* or *PSU*) that converts mains power (100V, 120V or 230V AC) into the much lower DC voltages utilized by the equipment. The PSU may be internal to the product, or it may be in a separate package, either with its own line cord or a "wall wart."

The PSU is connected to mains power through a transformer that steps the higher line voltage down to the needed low voltage, and feeds the rectifiers and regulator circuitry.

A power transformer intended for international use may have two or more primary windings that may be wired in series (for 220-240V mains) or in parallel (for 100-120V mains). The additional difference between 100V mains (Japan) and 120V mains (most of the Americas) may be accommodated by an additional primary winding, a tap on the 120V primaries, or even a boost/buck winding in series with the 120V primaries.

This sounds complicated, but for many products it is not, at least for the user. For products that offer this flexibility, the proper line voltage is usually set by a switch located near the mains power connector on the product that rewires that transformer primaries as needed. Some power supplies, especially those for small consumer products like computers, include circuitry that automatically detect the line voltage and either switch or adjust themselves to that voltage. A few products (primarily those designed for use by technically qualified users or for installation by sound contractors) may require that the installer open the equipment and rewire the power transformer primary.

The choice of power frequency is important in three ways. First, transformers and motors need a larger iron core to operate at 50 Hz, so a transformer or motor designed only for 60 Hz may overheat on a 50 Hz system. Second, the input filter capacitance must be 20% larger for a 50 Hz system. Third, any motor whose speed depends on the power frequency (a synchronous motor), or circuitry that uses the power frequency as a clock must be adjusted to the frequency in use. The easiest solution is to build the PSU with a transformer (and motors) that works with both frequencies. While the 50 Hz transformer may cost slightly more than a 60Hz unit, the difference is likely to be offset by an overall cost reduction if the same unit can be used worldwide, and can thus be built in greater quantity.

The third major difference that must be accommodated for the country of use is the proper power connector. The most common solution is to build the PSU with a chassis-mounted IEC power connector. The end user then provides the external power cord wired with the connector used in his/her country and sets the PSU to work with the line voltage and frequency.

INTERNATIONAL POWER CONVERSION

Equipment whose PSU is not easily adaptable to a different mains voltage can be accommodated by use of an external transformer to step 100 volts or 120 volts up to 230 volts or to step 230 volts down to 100 or 120 volts. Transformers suitable for use with small signal equipment are widely available through industrial distributors, but are likely to require the addition of one or more power connectors.

INTERNATIONAL SAFETY AND EMC LISTING

Most countries require that equipment connected to their power systems carry certification that they have been tested for safety, and for compliance with good engineering practice for EMC. Unfortunately, while these requirements are similar between countries, they are not the same (that is, they are not "harmonized" with each other). In addition, testing labs and certifications recognized by one country are often not recognized by another. The result is that the enforcement of safety codes and EMC certifications can make it impractical to buy equipment in one country and use it in another. While good safety and EMC codes are certainly important, there are some who view regulations not harmonized with other countries as a form of protectionism. The past two decades have seen considerable harmonization between the US and Canada, and between countries of the European Union. The world could use more of this – the laws of physics do not change at national borders, and reasonable people should be able to negotiate harmonized standards.

AUDIO AND VIDEO SYSTEM POWER REQUIREMENTS

In countries that utilize 230V 50 Hz power systems, virtually all audio and video equipment runs from standard outlets. With the exception of a few very large power

amplifiers and video projectors, virtually all audio and video equipment in the Americas utilizes single-phase 60 Hz power at 120V. Few individual pieces of equipment require more than 20A; most require far less current. The largest projectors and amplifiers may require 240V, 60 Hz, single phase power, at up to 20A.

Most audio and video equipment draws relatively little power. Audio and video equipment falls into two basic categories – **small signal equipment** and **large signal equipment**. Small signal equipment amplifies, processes, mixes, routes, and controls the signal. Mix desks, crossovers, equalizers, digital signal processors, routers, and switchers are all examples of small signal equipment. Nearly all small signal equipment has two characteristics in common – 1) it draws relatively little current, with the exception of very large mix desks, and 2) the current draw is essentially constant, independent of what the equipment is doing at any given time (as long as it is powered on). Power consumption ranges from 4-120 watts for most devices, including small mixers, to 1,000 watts or more for very large mix desks.

Large signal equipment is simply equipment that supplies an audio (or video) signal with considerable power – power amplifiers and video projectors. Within this type, there are two kinds of equipment – those whose power consumption is essentially constant, independent of the signal, and those where the power varies strongly with the signal level. Video projectors fall into the first class – they are either off or on, and their current draw will generally depend only on the light output.

The current (and thus the power) drawn by power amplifiers is very strongly dependent on how much audio power they produce, which in turn depends both on the signal level and the load impedance. There will be an “idle” or “quiescent” current that the amplifier draws when connected and turned on, but with no signal passing through it and only its small signal circuitry is operating. This power will generally be listed on the product data sheet, and 30-120W is typical of modern stereo power amplifiers. The power draw when the amplifier is actually providing output current is a far more complex matter, both because audio signals have very wide dynamic range, and because the average power is usually far less than the rated power.

Consider, for example, an amplifier that is part of a system for an auditorium that may be used for lectures, pop music, jazz, folk music, and live theater. Sound levels may vary by 30 dB from the loudest to the softest of these programs, and the system will rarely be required to get within 10 dB of full output. On the other hand, most power amplifiers exhibit their lowest efficiency when providing sine wave power at roughly 30% of full rated power. Not only that, but well-designed systems will have compression and peak limiting built in to maximize loudness and their ability to handle peaks, which will, in turn, increase the current draw by reducing the peak to average ratio. Thus, in a real system, the actual power drawn is not easy to know unless you actually measure the current.

Now, let’s look at the “nameplate” power listed on the amplifier itself, or on its data sheet. Most often, that’s the electrical power required to produce rated sine wave power, at clip. But we don’t use amplifiers to amplify sine waves, we use them to amplify audio program material, and the average power is virtually always at least 6 dB below that of a sine wave at clip. A far more useful data point is thus the current consumption under the more realistic conditions of pink noise (or, better yet, compressed pink noise) at clip (typically less than rated power). Even taking compression and peak limiting into account, audio systems actually draw far less power than the audio/video system designer asks the project Electrical Engineer to provide, even when pushed to the threshold of pain. When the program material is simply a person speaking, or even an amplified acoustic jazz band, the power amplifier will rarely draw more than about twice its quiescent power!

That doesn’t mean we don’t want to ask for an electrical system that can provide a lot of power – we certainly do – not to actually provide that power, but so that the power system will have good voltage regulation. That is, when the bass drum hits and the power amplifiers need a lot of current, we don’t want the power line voltage to “sag,”

because the performance of most audio gear degrades quickly with low line voltage. That requires big copper, both in the power distribution transformers and in the wiring to our system. It's hard to explain the dynamics of audio signals and the complex behavior of power amplifiers to an electrical engineer, so we simply ask for a lot more power than we really need. He responds by giving us big copper and a big isolation transformer for our system.

Cooling for audio and video systems is another issue that an audio/video system designer must address. The designer of the heating, ventilating, and air conditioning (HVAC) system needs to know:

- ♦ That the audio/video system will not always be on, and that it produces varying amounts of heat, depending on how it is being used.
- ♦ The quiescent (turned on and idling) heat produced by the audio/video system, in watts (I let the project Mechanical Engineer do the conversion to BTU). This is essentially the sum of the nameplate power ratings of all small signal equipment plus the idle current rating of all power amplifiers. If the equipment is split between rooms, the information is needed on a room-by-room basis.
- ♦ The maximum heat under full loading – that is, the system running at full power. This is essentially equal to the quiescent loading plus the dynamic power drawn by the power amplifiers, minus the electrical power fed to the loudspeakers. As noted in the discussion on dynamic power, this is a pretty tough number to come up with, but a value equal to 10 dB less than the combined nameplate AC current rating of all of the power amplifiers is probably conservatively high for their dynamic loading. This data is also needed on a room-by-room basis.
- ♦ That the ambient temperature in all rooms housing equipment racks must remain within the range of 10° – 27° C (50° – 80° F).
- ♦ That control rooms and rooms housing equipment racks must be controlled and served by the HVAC system independent of all other spaces.

THE START-UP PROBLEM

Most big power amplifiers have big power supplies with big filter capacitors connected directly to the output of the rectifiers. If, by chance, the power switch applies power at the peak of the AC cycle, a very large current will be drawn to charge the filter capacitor. This current can be much larger than that for rated sine wave power, but the current peaks quickly, and rarely lasts more than a few hundred milliseconds.

Circuit breakers are designed and specified to protect life and property in the case of a fault, primarily electrical shock and overheating due to excessive current. Conventional circuit breakers operate by a combination of thermal and magnetic means. The thermal means – a bimetal contact expands and contracts as it heats due to the current flow – has an intentional delay as sufficient heating takes place before the breaker trips. This delay allows the breaker to tolerate a moderately high turn-on surge current, as long as the current quickly settles to less than the long term rating of the breaker. The second mechanism is magnetic – it operates much more quickly, but takes a very large current to operate. A “high-magnetic” or “high-mag” breaker is designed such that the magnetic trip operates at a higher multiple of the steady state rating – that is, it allows a higher surge current.

Breakers used in Europe are classified by IEC 60898 as Class B, C, or D depending on how much surge current they pass in the first 100 msec. Class B breakers must pass 3x their nominal current for 100 msec, and trip on 5x; Class C must pass 5x and trip on 10x, and Class D must pass 10x and trip on 20x. A Class B breaker is a standard breaker, while a Class D breaker is a “high-mag” breaker. Compliance with IEC 60898 is sufficient for use in Europe. A comparable range of product types are used in the Americas, but building codes do not recognize IEC 60898, and require that UL or CSA listed products be used.

To prevent tripping on a turn-on surge, high-mag breakers should generally be used as main breakers and on the branch circuits of panelboards feeding power amplifier racks (and for convenience outlets around a facility that may be used with portable amplifiers). Ordinary circuit breakers will pass the turn-on surges associated with most medium-sized power amplifiers, and the use of high-mag breakers increases this capability. On the other hand, a breaker is much more likely to trip if several power amplifiers all turn on at the same time, and a main breaker for a large system may trip if many amplifiers in branch circuits all turn on simultaneously. [Note: Safety regulations often require that breakers trip within a specified time interval for a specified value of overload current. Using a "high-mag" or Class D breaker may eliminate nuisance tripping with turn-on surges, but it may also cause the circuit to fail the trip-time requirement if the circuit impedance is not sufficiently low. This can be avoided by using larger conductors on such circuits and making certain that there are no parallel paths for return current (as with a double-bonded neutral).]

There are several other good solutions to the start-up problem. One is to use a sequencing system that turns on one power amplifier at a time in intervals on of the order of one second, either by connecting only one power amplifier per branch circuit (i.e., one per breaker) and sequencing the breakers (Lyntec), or by using a sequencer after the breaker for multiple power amplifiers per breaker (SurgeX, EMO Systems). Another good solution is to "soften up" the turn-on of each individual amplifier, reducing its peak amplitude by spreading it out over much longer interval (SurgeX ICE). Another good method is to sequence the turn-on of the amplifiers themselves, either with an integrated control system (AMX, Crestron, etc.) or with control circuitry integral to the power amplifiers.

These systems must all have one thing in common if they are used in an assembly space – in the event of a power failure, the system must "remember" whether it was off or on when power dropped, and when power is restored, must automatically turn itself back on if it was on when the power dropped. Why? Simple. A power failure can easily coincide with an emergency condition, or could generate concern on the part of an audience. If the sound operator, seated in the audience, had to make a mad dash for the breaker panel to restore power after the failure, not only is time lost, but a panic could be triggered by the commotion of someone running to restore power.

POWER SYSTEM ARCHITECTURE

The connection of a building to a source of power is called the **service** and the point where the connection is made is called the **service entrance**. The power company's local distribution lines (just outside the building) operate at relatively high voltages (typically 2.3 kV – 12 kV) to minimize IR (voltage) drop and I^2R (power) losses in the wire. In each neighborhood, the power company installs large transformers (typically on poles, in underground vaults, or in above-ground enclosures) to step down the high distribution voltage (high impedance) to the lower voltage (impedance) used for interior wiring (called **premises** wiring).

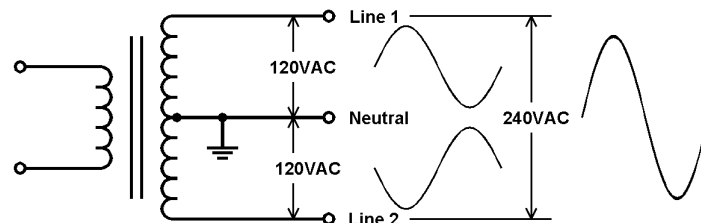

Figure 1 – Single Phase 120V/240V Power System ("split single-phase")

In countries where outlets are wired with 100V or 120V, power is typically distributed to a facility in one of several forms. A few very small facilities (typically homes and small churches) may have only 240V or 120V single-phase service. Single phase power is nearly always provided by a transformer having a center-tapped 240V secondary, as

shown in Figure 1 (this system is often called “split single-phase”). The center-tap is grounded and becomes the neutral for 120V equipment and for outlets connected to either Line 1 and Line 2. Note the voltage waveforms for Line 1 and Line 2 are out of polarity with each other, so that large equipment that needs 240 volts connects to the entire secondary winding (and no connection to neutral unless that equipment also needs 120V). A few older homes may have only a 120V service, but it is likely that the distribution transformer outside the home has a 240V center-tapped secondary, even though only one side is brought into the home.

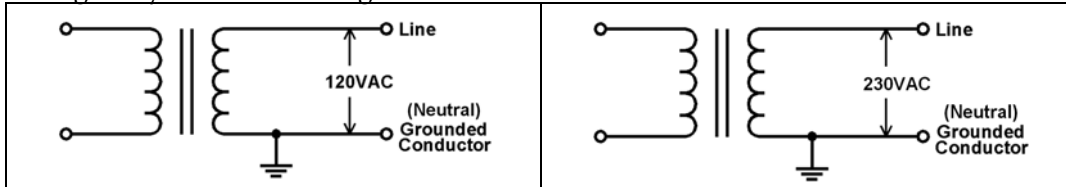

Fig 2 – Single Phase systems

At this point, a comment about terminology is in order. The National Electric Code, which is widely used in the Americas, uses the term ***Grounded Conductor*** when referring to the return conductor of a 120 volt circuit. Almost everyone else calls this conductor the ***Neutral***, and we shall use the two terms interchangeably here.

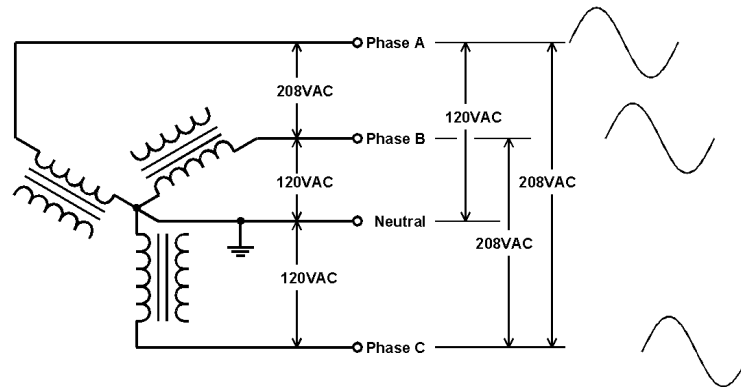

Figure 3a – Three Phase 208V/120V Power System (The Americas)

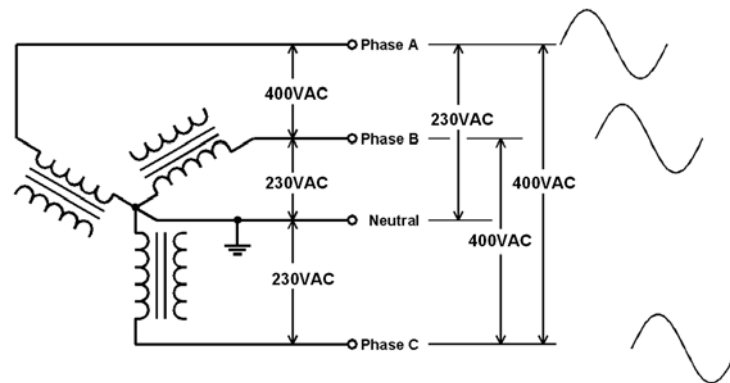

Figure 3b – Three Phase 400V/230V Power System

Nearly all power is produced by rotary generators, whose output is taken from three windings displaced by 120 degrees from each other around the generator shaft. The electrical phase of the power produced by the three windings is also displaced by 120 degrees at the 50 or 60 Hz power frequency. We call the power produced by such systems “three-phase” power, because the power consists of three components, each displaced by 120 degrees from each other.

Large facilities are connected to a three-phase ***service***, as shown in Figure 3a or 3b.

Three phase power is required to run most large motors. Figures 3a and 3b show that the voltage waveforms for the three phases are displaced from each other by 120 degrees. Figure 4a shows these voltages as “phasors,” a mathematical concept developed to analyze and describe how voltages *of the same frequency* but out of phase with each other combine with each other. We can think of these phasors as vectors that rotate around an origin, with the vertical height of the vector tracing a sine wave as it rotates.

We can “stop” these phasors at any point in time and analyze how they combine. Figure 4a shows them at the point where the voltage on phase A happens to be at 0 degrees, but we could have stopped them at any other point on the cycle. Figure 4b shows that when any two windings are in series (that is, we measure phase-to-phase) the voltage is 1.732 x the voltage of any one phase. Thus, a 3-phase system that has 120 VAC between each leg and neutral will have $1.732 \times 120V = 208VAC$ from phase to phase. Why not 240 volts (or zero)? Because the two voltages are displaced by 120 degrees, not 180 degrees as in the case of a single phase (center-tapped) system. The constant 1.732 results from the 120 degree relationship between the phases. It applies to the ratio between single-phase and three-phase power systems, no matter what the voltage.

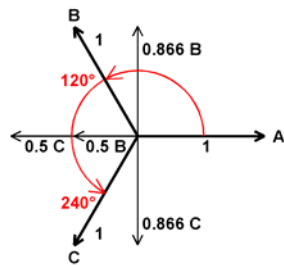

Figure 4a – 3-Phase Voltages

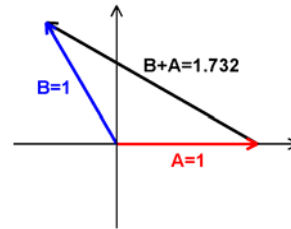

Figure 4b – Phase to Phase Voltage

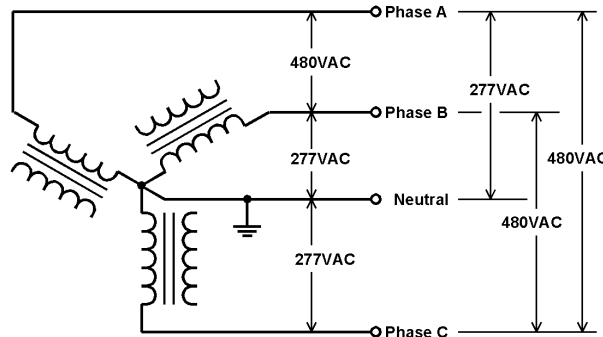

Fig 5 – Three Phase 480V/277V Power System

In countries where 120V/208V power is standard, the largest facilities are typically connected to a 480V/277V service in a three-phase wye configuration, as shown in Figure 5, or a three-phase delta, as shown in Fig 6. Some of that power may be utilized directly at the supplied voltage for large motors and fluorescent lighting, but distribution transformers inside the building will also step that voltage down to 208V/120 V wye for use by most equipment and systems. Again, three-phase power may be used to run motors, but most power will be distributed at 120V single phase to equipment and outlets. Phase relationships are the same as for 208V/120V systems – the two systems differ only in the turns ratio of the distribution transformers and the voltage rating of their components. A transformer fed from one of the phases and having a 240V center-tapped primary (Fig 1) will be used to feed high power equipment that needs 240V and can also be used to feed 120V to equipment and ordinary outlets. Where 230V/400V power is standard, even the largest buildings will have a 400V 3-phase feed.

The three-phase Delta configuration (Fig 6) has no neutral. This configuration is used only in industrial buildings and in distribution outside of buildings. One leg may be grounded, but NEC does not require that there be a grounded conductor.

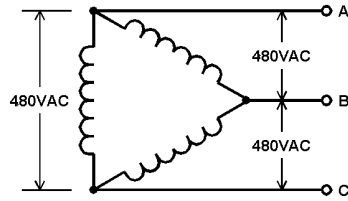

Fig 6 – 480V Delta

NEUTRAL CURRENT AND HARMONICS

It is good practice to balance loads between the legs (phases) of a three-phase system. Fig 7 shows the relationships between the current in the neutral of a perfectly balanced three-phase system. Fig 7a and 7c show neutral current at the fundamental frequency of 60 Hz. Taking phase A as the reference, the .866 positive and negative components of phases B and C cancel each other, while the 0.5 components add to perfectly cancel phase A, so the total neutral current is zero. If all current in a power system is sinusoidal, Fig 7a and 7c tells us all we want to know about the current in the neutral.

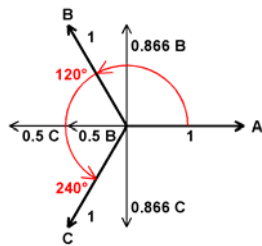

Fig 7a

Neutral current at 50/60 Hz

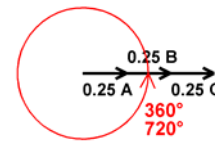

Fig 7b

Neutral current for 25% third harmonic

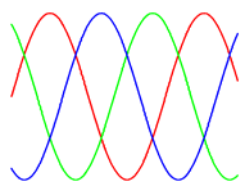

Fig 7c – Sinusoidal neutral currents (red=A, green=B, blue=C)

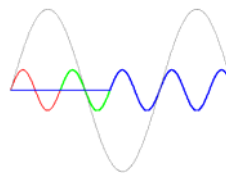

Fig 7d – Third Harmonic (fundamental of one phase shown for reference)

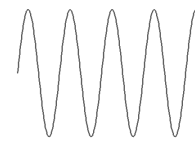

Fig 7e three phases summed, each 25% 3rd harmonic

Unfortunately, the current drawn by the power supplies in electronic equipment is almost never a pure sine wave. Power supplies have some form of rectifier that then recharges a filter capacitor at each peak of the input sine wave. This results in the current waveform being a very distorted sine wave. Forty years ago, most of the current in a building was drawn by loads that were relatively sinusoidal – motors, incandescent lighting, heaters, and so on. We would say that these loads are relatively linear – that is, the current they draw is almost directly proportional to the sine wave voltage, so they are close to being an undistorted sine wave. There were a few electronic loads – radios, hi-fi rigs, etc., but they were a relatively small fraction of the total current drawn by a building. Over the past 25 years, incandescent lighting has been replaced by fluorescent lighting, and computers, office machines, and all sorts of electronic equipment have proliferated. These non-linear (highly distorted sine wave) loads now constitute a very high percentage of the load on the power system in most buildings.

More than one hundred years ago, the mathematician Fourier taught us that any periodic (repeating) signal consists of an infinite series of sine waves – what we now call a fundamental frequency and harmonics. We now know that the greater the distortion, the greater the number and strength of the harmonics. Thus, the load current of virtually all buildings is rich in harmonics. Some very interesting (and potentially dangerous) things happen in a 3-phase system with some orders of harmonics. Figure 7b and 7d

show why, this time using the third harmonic of phase A as the reference. Since the phasors are at three times the frequency, they are $3 \times 120^\circ$ apart at their third harmonic. We see that phase B lags 360° behind phase A, and phase C is 720° behind phase A. This makes these third harmonics exactly one complete rotation from each other in the neutral, so they add rather than cancel. A similar relationship exists for odd multiples of the third harmonic – 3rd, 9th, 15th, 21st, and so on (called “triplen” harmonics).

The practical meaning of Fig 7b, 7d, and 7e is staggering – they show that a relatively high harmonic distortion can cause neutral current to exceed the current in one of the phases of a system, even a system that is perfectly balanced! Fig 7b shows only a 25% third harmonic adding to 75% of the current in one phase. But the third harmonic can be even stronger, and there can be other triplen harmonics present. In fact, it is not unusual for the current in the neutral to exceed 175% of the current in one phase! This current can cause overheating of wiring and other hardware that make up the neutral circuit due to I^2R losses.

This behavior of triplen harmonics occurs anywhere they are summed – as leakage currents in the Equipment Ground (PE) conductor, and as magnetic fields produced by transformers, motors, and wiring. As we shall learn later, this makes power-line buzz far worse than it otherwise would be if no 3-phase currents were present.

Equally important, core losses in transformers and motors increase quickly with increasing frequency, so harmonic current significantly increases core losses (heating) in these critical components. The power industry has devised the “K-factor” to describe the harmonic current in a system, and transformers are assigned a K-rating based on their ability to handle these high levels of harmonic current. The K-factor takes the strength of each order of harmonic into account.

$$\text{K-Factor} = \sum (I_h)^2 h^2$$

where I_h is the load current at harmonic h , expressed in a per-unit basis such that the total RMS current equals one amp. One problem associated with calculating K-Factor is selecting the range of harmonic frequencies that should be included. Some use up to the 15th harmonic, others the 25th harmonic, and still others include up to the 50th harmonic. For the same load, each of these calculations can yield significantly different K-Factors because even very small current levels associated with the higher harmonics, when multiplied by the harmonic number squared (e.g., $50^2 = 2500$), can add significantly to the K-Factor. Based on the underlying assumptions of C57.110 (the Standard defining K-Factor), it seems reasonable to limit the K-Factor calculation to harmonic currents less than the 25th harmonic.

What sort of K-factors should be expected from audio and video systems? The answer is complex, because the relative strengths and phase relationships of the harmonics produced by different equipment can vary significantly from one to another, depending on their design, and their mode of operation. Power amplifiers could have a much higher K-factor at idle than when providing their maximum output. Switching power supplies may have different harmonic structures from simple full-wave rectifier/filter supplies (but switching supplies include a full wave rectifier/filter supply to drive the switching oscillator). K-factors for loads that consist almost entirely of electronic equipment are typically in the range of 12 – 20, but many loads might combine for a K-factor of 3-6 for an entire building or system.

A common rule of thumb in 3-phase systems is to install neutral conductors and hardware rated for 2X the current in any phase. Electrical components are manufactured with K-ratings of 1, 4, 9, 13, 20, 30, 40, and 50. A relatively conservative designer might specify a K-rating of at least 13 for all transformers serving audio system loads. An applications note explaining K-factor is at

http://www.liebert.com/support/whitepapers/documents/sl_24200.asp

HIGH LEG DELTA

Figure 8 shows a variation of the delta configuration that is widely used in North America, especially in older mixed residential and industrial areas, and in rural areas. One leg of the delta has a grounded center-tap that serves as the neutral for a single-phase 120/240VAC system, and 208 volts is available for certain industrial applications. Also known as a Red Leg Delta, or Wild Leg, High Leg Delta systems must have that phase conductor marked with orange tape, orange finish or similar. This marking is only required where a connection is made and the neutral conductor is present.

The configuration can work for audio and video systems if there are no other loads on the transformer. But EMC consultant Neil Muncy has taught us that when High Leg Delta is used to feed multiple customers from the same transformer, the neutral currents from one customer can circulate through another customer's ground system. When this happens, the neutral feed from the pole-mounted transformer may carry relatively large neutral currents from those neighboring buildings.

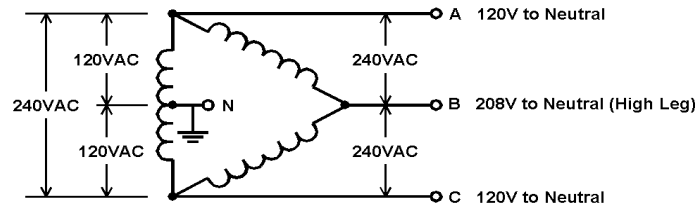

Fig 8 -High Leg Delta

The neutral current will find its way to earth through the **system earth** at the **service entrance**, and in general, the better the earth electrode system, the greater the circulating current will be! If the path to earth runs near audio equipment or wiring, the magnetic fields produced by these currents can couple into system wiring, guitar pickups and dynamic microphones without hum-bucking coils, and even the electronics of audio gear. The result is hum and buzz that can be eliminated only by eliminating the field. The hum component is 60 Hz, while the “buzz” consists of harmonics. When called in to diagnose problems in a small recording studio complex in a renovated industrial building, Muncy found a High Leg Delta power feed with 7A of neutral current finding its return path via a water main running under the guitar isolation booth!

The solution is to use a transformer with a single-phase center-tapped secondary (Figure 1), to feed 120/240 v systems in the building, powering it from one of the ungrounded 240 volt phases. What matters is that the shared neutral feed to the building, with the offending currents, must be eliminated.

GROUNDING (EARTHING)

The primary purpose of grounding is life safety and the protection of both property and equipment. The principal hazards are lightning, power line voltage spikes, and equipment or wiring faults (failures) that could place power voltages on exposed equipment (where someone might touch it and be electrocuted) or cause a fire.

While the power company's equipment and wiring are generally not covered by building codes, nearly all power distribution systems are earthed. Most distribution transformers have a conductor bonded to a rod driven into the earth. If that transformer is on a pole, there will be a downlead on the pole from the transformer to the rod. The primary function of this earth connection is lightning protection – it is rarely a very good ground, and may be electrically noisy.

Two grounding functions are required by building codes. **System grounding (earthing)** is the connection to earth of a conductor that normally carries current – the **Grounded Conductor** or **Neutral**. **Equipment grounding (earthing)** is the bonding together of all exposed equipment and structure, and the connection of that bond back to the power system ground (earth). Equipment earthing is accomplished by means of the **Equipment**

Ground conductor ("*the Green Wire*"), in some countries called the **Protective Earth (PE conductor)**. The details of how and where these connections are made varies a bit from one country to another, but not by much. While this discussion specifically describes building codes (regulations) that apply in North America, the only significant differences in most parts of the developed world are the words (and jargon) used to describe practices and standards that are essentially the same, the extent to which all exposed metal is bonded together and to the Equipment Ground, and the extent to which outlets and plugs used in that country insure that equipment will be properly connected to the **Equipment Ground**.

Electrical codes require that most **systems** have a **Grounded Conductor (Neutral)**. A **system** in this sense of the word is any network of power wiring fed by a single source (a transformer or a motor generator), whether that source is outside the building or inside the building. When the source is outside the building, the **Grounded Conductor (Neutral)** must be bonded where it enters the building (this connection point is called the **service entrance**). The bond must be carried to all earth-connected metal in the building – building steel, cold water pipes, and driven ground rods. This connection of the **system** to ground to create a **Neutral** is called the **System Ground, or System Bond, or Main Bonding Jumper**. [In some countries, including parts of the UK, neutral is bonded to earth only at the power company's equipment, external to the building.]

The **System Ground, (System Bond or Main Bonding Jumper)** must be at the point where the system is **established**. A power system is most often **established** when a transformer is connected to an existing system – for example, 480V/277V power coming into a building must be stepped down to 208V/120V to feed ordinary appliances and lighting circuits. The secondary of that transformer **establishes** a new **System**, called a **Separately Derived System**, and the **Neutral** of that new **System** must be bonded to create the **system ground**.

Which Power Systems Must be Grounded?

<u>Must Be Grounded</u>	<u>May Be Grounded</u>
120/240V single phase (Figure 1)	Systems that do not use a neutral as a circuit conductor 3-wire Delta (Figure 6)
120/230 V single phase (Figure 2)	
120/208V and 230/400V wye (Figure 3a, 3b)	
120/208V/240V High leg Delta (Figure 8)	

The principal function of the **System Ground** is to protect against lightning. Lightning occurs when a very large charge develops between the atmosphere and the earth. Eventually the charge builds to the point where it will arc over to complete the path to earth. Consider what would happen if the system was not grounded, and power wiring was struck by lightning (became part of that path). That very high voltage (thousands of volts) would appear on house wiring, and at some point of its own choosing, would arc over to other conductors that would take it to ground. That arc could easily start a fire, either directly or by the heat produced by I^2R losses in the path to earth, and the buildup of voltage could seriously injure or kill a person nearby. If the **System** is well **Earthed**, the lightning charge is far more likely to be conducted to earth via a path that is safe, away from people that could be hurt by it, and, with a little luck and good wiring practice, without starting a fire or causing other damage.

Note that a transformer does not isolate grounds on one side for the transformer from those on the other side. That's because safety codes also require that all grounded objects (and all grounded **Systems**) in a facility must be bonded together.

Safety codes generally require that all exposed conductive objects (**Equipment**) that may be energized (that is, could somehow contact a "hot" phase wire) be grounded. This is called the **Equipment Ground** (also called the **Green Wire, Protective Earth, or PE**). Virtually ALL electrical equipment enclosures and raceway – conduit (trunking), cable tray, transformers, backboxes, etc. are required to be bonded (together and to ground).

Figure 9 shows how **System Grounding (Earthing)** and **Equipment Grounding (Earthing)**

combine to protect from faults. The transformer center-tap has been grounded (this is the **System Ground**), and some system failure has caused line 1 to be shorted to a grounded object. Perhaps, for example, a line 1 wire has been mashed into a conduit fitting. Since Line 1 is now connected directly to its own neutral (via the **Equipment Ground** and the **System Ground**), the fuse in Line 1 blows (or the circuit breaker trips). The blowing of the fuse (or tripping the breaker) is how **Equipment Grounding** and **System Grounding** protect against power faults! In other words, **the principal function of Equipment Grounding is to blow a fuse or trip a breaker when something goes wrong!**

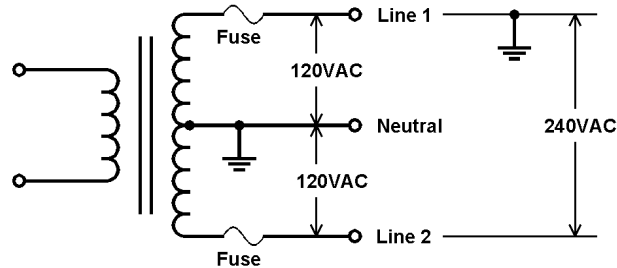

Figure 9 – A Fused Single-Phase System, with a Fault (short to ground) on Line 1

Note also that codes require that all systems be protected by a fuse or breaker before the first **means of disconnection** (circuit breaker or fuse), and that the **System Ground** bond must also be upstream of that disconnection. The reason is simple – the **System Ground** and fuse/breaker must be there to protect from faults!

Equipment Ground is required to be carried with the **phase** and **neutral** conductors to every distribution panel, and from there to every place where power is extended. In some jurisdictions a dedicated **Equipment Ground** conductor is required (green is the assigned color). In other jurisdictions, the dedicated wire is optional if the **Equipment Ground** is carried by properly installed conductive raceway. The **Equipment Ground** includes the bonding together of every piece of building steel to every piece of metallic conduit (trunking) and electrical equipment.

If a steel raceway system (trunking) is used and is properly installed, including the correct installation of **listed** fittings at all junction points, it will generally provide a much lower impedance fault path than if there were only a dedicated green wire (**Equipment Ground, PE**) (green/yellow in Europe). But installing a dedicated green wire is **always** good practice, because it serves as a backup to the conduit connection, which can become intermittent, especially if the conduit (trunking) is not well installed. When that additional wire is used, NEC requires that it be bonded to each enclosure through which it passes.

Virtually all electrical codes require that the **Equipment Ground** be run with the associated circuit conductors – that is, they must follow exactly the same path, and if in conduit (trunking), must be in the **same** conduit. If not in conduit, all three conductors – **phase, neutral, and Equipment Ground (PE)** should be in a single cable with all conductors molded together. There are two very good reasons for this. First, any mechanical event that caused interruption of one conductor is likely to also cause interruption of the others. Second, the inductance of the fault path for the current is far lower if the conductors are closely spaced, because the magnetic field for the current flowing through the phase conductor is cancelled by the field produced by the return current through the **Equipment Ground (PE)** conductor. Lower inductance means that the fault current will be greater and rise to a peak value more quickly, making it more certain that the protective fuse or breaker will be activated, and activated more quickly (before personnel are injured or a fire starts).

Some countries are more rigorous than others about making certain that the **Equipment Ground (PE)** is bonded to building steel and other earthed objects at multiple points and where outlets are installed. Steel conduit has long been used in North America to protect wiring, and it must be bonded to the Equipment Ground. But steel conduit is not

required in most jurisdictions, and the cost of installing (mostly labor) has made it much less common. In much of North America, residential wiring uses three conductor cable in a flexible molded PVC jacket. The cable runs "exposed" (not in conduit) inside walls, over ceilings, and under floors.

In the Americas, an earth connection is required at the *service entrance* (the *System Bond*). Additional earth connections may be made to the *Equipment Ground (Green Wire, PE)* anywhere along the system (but not to the Neutral), but all earth connections must be bonded together. In the UK, actual earth connections must be connected to the PE only at the *service entrance*.

GETTING TO EARTH – THE EARTH ELECTRODE SYSTEM

The principal function of the Earth Electrode system is to provide a very low impedance path to earth for lightning and other high voltage transients (spikes) that may be on the mains power line. IEEE studies have shown that lightning energy is very broadband, extending from dc to well into the MHz range, with a broad peak around 1 MHz. It is this energy for which we must provide a low impedance path to the earth. At 1 MHz, the dominant electrical characteristic of the System Earth conductor is its *inductance*, not its resistance, and the inductance of a wire is almost entirely determined by its *length*. To minimize the impedance (virtually all inductive reactance) of this conductor, it is critical that it be as *short* as possible. Inductance, like resistance, is reduced by having many paths in parallel, or by making the connection by means of a very wide copper strap or braid. Braid is generally less desirable, since it corrodes much more quickly than strap.

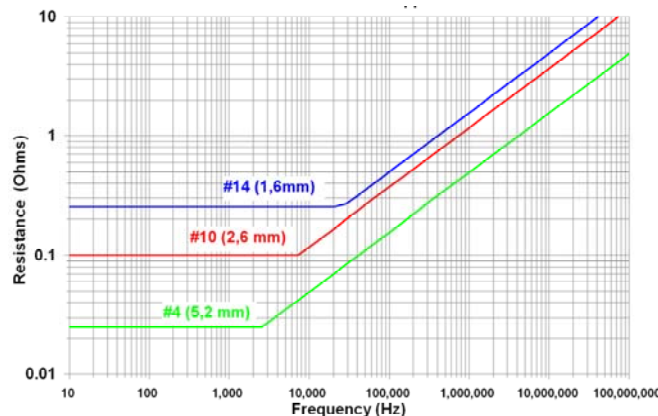

Figure 10 – Resistance of 100 ft (30,5m) of Copper Wire, including Skin Effect

Much is made in the popular press of skin effect – it is well known that it causes the resistance of a wire to increase with increasing frequency as the magnetic field causes current to be pushed to the outer surface of the conductor. Figure 10 shows the resistance of stranded copper conductors that might be used for System and Equipment Grounding. At low frequencies, there is negligible skin effect, so the curve is horizontal. Skin effect is responsible for the increasing resistance.

Skin effect increases with increasing frequency, and is a function of conductor diameter and geometry. The graph computed for Fig 10 is for round, non-magnetic conductors. It is interesting that, contrary to sales hype in the world of high fidelity, skin effect is essentially insignificant at audio frequencies for conductors of sizes normally used for audio system wiring. It is not, however, insignificant for the larger conductors used for system feeders. Indeed, the 4/0 conductors are already showing significant skin effect at 180 Hz, and should be de-rated when used as neutral feeders in 3-phase systems.

Figure 11 shows the inductive reactance of a straight non-ferrous conductor in free space, not close to the conductor carrying its return current. The loop inductance will be much smaller for a conductor running in close proximity to its return conductor (for example, in typical paired cable).

The free space wavelength of 1 MHz, the frequency for which this data is computed, is about 984 ft. Antenna effects will begin to show up when a wire is 1/10 wavelength at the frequency of the signal it carries, and a wire will resonate at multiples of one-quarter wavelength. The first resonance at 1 MHz would be around 240 ft, and the actual behavior of the wire could be expected to begin deviating from these curves when it is longer than about 100 ft. For a 2 MHz signal, the first resonance would be around 120 ft, and antenna effects would begin to show up when the wire was longer than about 50 ft. This graph ignores all antenna effects.

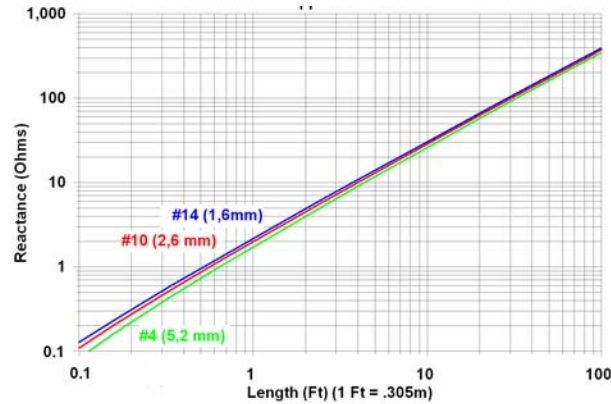

Fig 11a – Inductive Reactance of a Straight Conductor at 1 MHz, ignoring antenna effects

Antenna effects can vary widely, depending upon many variables. Even the simplest analysis is beyond the scope of this white paper. Depending on whether the wire is connected on the other end, how it is connected, what it is connected to, and whether length is an odd or even multiple of quarter waves long, the wire might appear as a near short circuit, a near open circuit, or anything in between!

Figure 11a clearly shows that increasing the diameter of the grounding conductor reduces inductance only slightly. Indeed, the only good reason for using a large conductor is to reduce the resistance, which will, in turn, reduce heating during lightning strike conditions and might prevent the conductor from vaporizing!

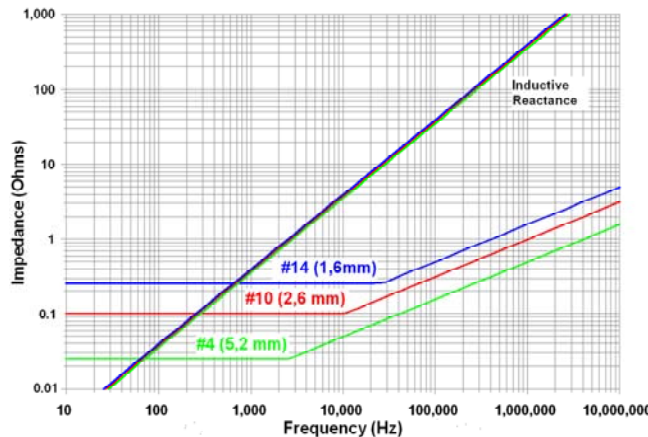

Fig 11b – Resistance, with Skin Effect, and Inductive Reactance for a 100 ft (30m) Wire

Figure 11b makes it clear that, above a few hundred Hz, and for most conductors of practical size, inductance is far greater significance than resistance! It also shows that to provide anything approaching effective lightning protection the System Ground must be very short, and many paths to earth must be provided in parallel. In many buildings, those parallel paths can be provided by building steel. In fact, if all of the structural steel in a building is well bonded, the impedance to earth through that structure is likely to be an order of magnitude lower than through any ground electrode system that can be installed at anything approaching reasonable cost. For this reason, most building codes (including NEC) call for making the **system ground** bond to building steel

unless none is near the point where the **system** is established.

But there is another very important factor that these graphs don't take into account – if the ground conductor is running in steel conduit, its inductance will be greatly increased (by as much as 40X), because of the higher permeability of the steel! Luckily there is a simple solution – the ground conductor must be bonded to the conduit at each end, and at each junction. When this is done, the copper conductor and the conduit are in parallel. At higher frequencies, skin effect will cause nearly all of the current to flow on the outer skin of the conduit, while at power frequencies a greater percentage will flow in the copper. When this is done, inductive reactance can approach the curve for the 2" (5cm) diameter tube.

Inductance is not the only factor limiting the impedance between an electrical system and the earth. The conductivity of soil varies widely depending on its composition and is also a function of moisture content. Building codes are generally lax with respect to the quality of the earth connection that must be provided. The National Electric Code (NEC) requires, at a minimum, a single ground rod be driven. If the impedance to earth is greater than 25 ohms, it requires that a second rod be driven and bonded to the first, but it does not require that the combined impedance be any specific value. Both NEC and good engineering practice require that all **made electrodes** (intentional earth connections) be bonded together, and this bond should be outside the building.

The calculations to predict the impedance to earth of a ground electrode system are complex, and are rarely worth the trouble. Following the guidelines below is generally enough to satisfy the needs of audio and video system earthing. Also, the earth electrode system will be in parallel with building steel and the concrete foundation. In general, the impedance to earth of the earth electrode system will be minimized by:

1. Using more earth electrodes.
2. Making the earth electrodes longer, driving them deeper into the earth. Ten feet (3 meters) is generally considered to be a minimum depth.
3. Spacing earth electrodes as far apart as practical (spacing equal to at least their length). Separation is important because mutual coupling between closely spaced electrodes increases their impedance to earth.
4. Placing electrodes where they will be continuously exposed to moisture (rain-fall). For this reason, earth electrodes should be outside the building footprint.
5. Avoiding chemically enhanced electrode systems. These systems require long term attention to maintain their chemical balance. Few facilities are likely to have staff trained to do this.
6. Increasing the surface area in contact with the earth, or by using an electrode of greater cross-section of greater length, or by means of a Ufer (an earth electrode buried in concrete). (Fig 12)

The resistivity of various types of concrete varies over at least four orders of magnitude, depending on the formulation and how it is poured. Some concretes are specifically designed to be conductive, and can be used to encase the grounding electrode (Figure 12), thus increasing the surface area in contact with earth. Such an electrode is called a Ufer. Other applications of concrete require that it be the best possible electrical insulator (for example, railroad ties for electric railways). Structural steel encased in concrete can made a part of the ground electrode system simply by thoroughly bonding all elements of the rebar together and bonding from there to the System Ground. See http://www.polyphaser.com/ppc_PEN1030.asp The Engineering Notes on this website are an excellent resource for understanding the engineering issues associated with grounding for lightning protection, especially for radio facilities. Not all of their methods are directly applicable to audio and video systems, but many are.

The conductivity of concrete must be considered when installing equipment racks on a concrete floor. As we will learn later, audio and video equipment racks should be iso-

lated from earthed objects and then earthed through a **Technical Ground (Earth) System**. A good way to accomplish this is to place one or two layers of 5/8" ribbed or waffled neoprene pads between a rack and a concrete floor. This provides both electrical and acoustic isolation of the racks. If the racks are bolted to the floor, suitable insulating grommets will be required.

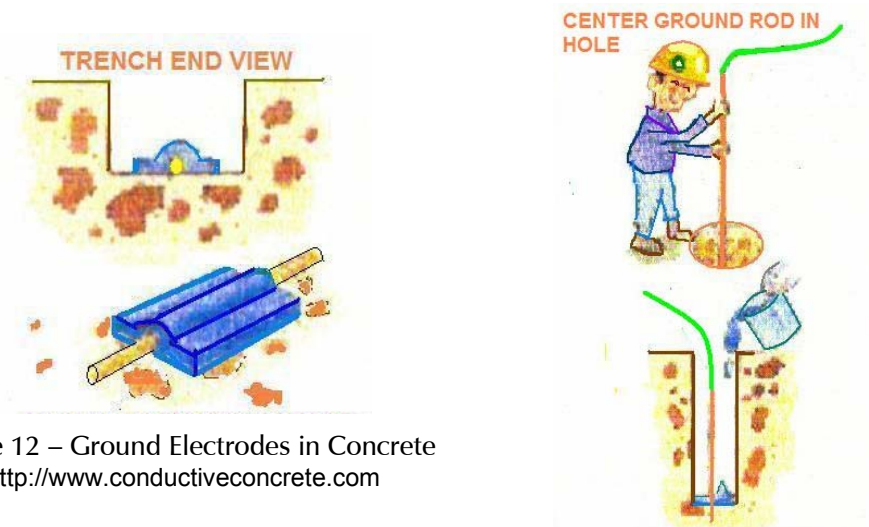

Figure 12 – Ground Electrodes in Concrete
<http://www.conductiveconcrete.com>

TECHNICAL EARTH SYSTEMS – MINIMIZING VOLTAGE BETWEEN EQUIPMENT

Up to now, we have talked only about earthing for safety and the protection of equipment. From this point on, we'll talk mostly about grounding (earthing) to minimize noise in audio and video systems.

One of the fundamental rules of system interconnection is that the shields (screens) of cables carrying audio frequency signals should not carry current, especially at the frequency of those signals. A condition that results in noise current on the shield (screen) is often called a "ground loop." There are four important reasons why shield (screen) current should be avoided. All relate to imperfections in audio equipment and wiring.

1. Much audio and video equipment has been manufactured with a design defect commonly known as "the pin 1 problem," whereby the shield (screen) of signal wiring is connected (improperly) to the printed circuit board rather than (properly) to the shielding enclosure. With this improper construction, any current flowing on the cable shield (screen) will be coupled into the equipment, amplified, (and RF will be detected), and heard as noise.
2. Virtually all shielded (screened), twisted pair cables sold in North America for permanent installation exhibit a design defect that causes what Neil Muncy has named "shield-current-induced noise" (SCIN). The shields (screens) of these cables consists of aluminum foil with a copper wire (called a "drain" wire) in contact with the foil. In nearly all of these cables, the drain is twisted at the same rate as the signal conductors, but is closer to one signal conductor than the other. Any current flowing on the shield (screen) will induce a voltage in each conductor of the signal pair. Below about 4 MHz, nearly all of the shield (screen) current flows in the drain wire, because its resistance is much lower than that of the foil. Because the drain is physically closer to one conductor than the other, shield (screen) current will induce more voltage in one conductor than the other. In other words, shield (screen) current is converted to a differential voltage on the signal pair. SCIN in foil/drain cables is less of an issue above 10 MHz, as skin effect takes over and a higher percentage of shield current flows in the foil.
3. Much audio equipment lacks filtering to reject radio frequency interference

(RFI), so when SCIN places RF on the signal pair, that RF enters the equipment, is detected (converted to audio) and appears as noise (or the broadcast program) in the audio.

4. In unbalanced circuits, shield (screen) current causes an IR drop that is added to the signal (because the shield (screen) is part of the signal circuit. (See *The Problem With Unbalanced Wiring*)

Three fundamental mechanisms can produce shield (screen) current.

1. **Potential differences between the two ends of the cable.** Current will flow on the shield (screen) if the two ends of the cable are at different potentials. Consider a cable shield (screen) that is bonded to equipment enclosures at both ends, the equipment is plugged into widely separated outlets, and the equipment at either (or both) ends of that cable has capacitance between the the AC power line and its enclosure. Virtually all power transformers will have capacitance between their windings and the enclosure, and nearly all technical equipment has EMI filters that include capacitors between the power line and the PE. Many fault conditions in power system wiring can establish potential differences of several volts between the PE connections at different locations. To understand how these voltages are produced, see the following discussion of *leakage currents*.
2. **Magnetic induction.** Voltage will be induced along the shield (screen) if the cable passes through a magnetic field. If the shield is connected at both ends, current will flow.
3. **Antenna action.** In the words of Neil Muncy, “You say audio cable, but mother nature says “antenna.” Any radio signal can cause current to flow on the shield (screen).

LEAKAGE CURRENT AND APPLIANCES

Equipment connected to the power line will draw current through capacitors intentionally connected between the power line and its enclosure (noise filters), and through unintentional parasitic (stray) capacitance and resistance inherent in power supply components. The return path for this current is the *Equipment Ground (Green Wire, PE)*. The resulting IR drop along the *Green Wire (PE)* raise the potential (voltage) on the enclosure.

IEC 61140 established four classes of electrical appliances that may be connected to the mains supply based on their leakage current. Class II products are those having no exposed metal parts, or exposed metal parts that are double-insulated from mains power. [Class III products are those having no internal voltages exceeding 50VAC or 120VDC. In Europe, they may be connected only to PELV and SELV circuits. Class 0 (zero) products do not fit into one of these categories, and are not permitted at all.] Class I products have exposed metal parts that are bonded to the PE conductor. Class II products have a two-circuit plug that makes contact only with the hot (phase) and neutral conductors. Class I products must use a 3-contact plug that bonds exposed metal parts to the PE conductor.

For Class II products, and for Class I products that are hand-held, leakage current must be less than 0.25mA. For other Class I products leakage current must be less than 3.5mA. Products are tested with a simple network that places 1,000 ohms in series with the PE, a 10,000 ohm resistor in series with a broadband high impedance AC voltmeter measuring the voltage across the resistor and a 15nF capacitor across the voltmeter. The RC network forms a 1MHz low pass filter, so the measured current includes harmonics of mains power. If the product has no exposed metal parts, leakage current is measured through conductive foil that is in contact with the product and surrounds it.

Capacitance is the primary source of leakage current, so we can solve the equation for capacitive reactance and current for these two classes of appliances and standard

power systems. For a Class II device, the maximum permissible capacitances between mains and the enclosure are 5.5 nF for 120V 60 Hz systems, and 3.3 nF for 240V 50 Hz systems. For Class I devices, maximum permissible capacitance is 78 nF for 120V 60 Hz systems, and 41 nF for 240V 50 Hz systems. These values assume that no high order harmonics of mains voltage are strong enough to contribute to leakage current.

A single Class I appliance is permitted to draw no more than 3.5mA, but the leakage current on one **Green Wire (PE)** can be significantly greater if several appliances are plugged into multiple outlets connected to the same **Green Wire** (for example, four outlets in a permanently installed "quad box" or a multi-outlet strip plugged into an outlet).

There are other powerful sources of leakage current, primarily resulting from poor circuit design, improper installation, and loopholes in regulations that permit those conditions to exist. As an example, consider the controllers for lighting systems or variable speed motors, where controllers are widely separated from the lights or motors they control, and the control is accomplished by varying the width of square pulses of voltage and current to the device being controlled.

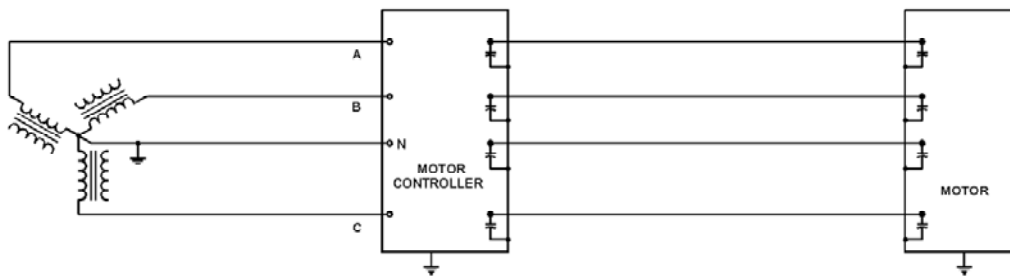

Fig 13 – A Variable Speed Motor and Controller

The variable speed motor controller shown in Fig 14 is a powerful source of rather nasty leakage current and RF noise. It operates by rectifying the AC supply, then generating square wave pulses whose width are varied to adjust the motor speed. Any motor will have capacitance between its windings and its frame, and controllers will almost always have bypass capacitors from each line to its enclosure, which in turn is bonded to Equipment Ground (PE). The repetition rate of these square wave is typically on the order of tens of kHz, with harmonics extending into the hundreds of kHz. It doesn't take much capacitance to allow hundreds of mA (or even amperes) of leakage current!

Because they couple strong leakage currents onto the PE (equipment ground) conductor, variable speed motors and dimmed lighting systems are major sources of strong magnetic fields that can couple into audio circuits. The highest order harmonics can radiate to cause strong RF interference that extends well into the MHz range. Both Neil Nuncy and the author have seen systems where quite severe RF interference was coupled by SCIN and pin 1 problems in microphone systems, where it is heard as a strong buzz. These systems are well known to cause severe interference to AM broadcasting and short wave radio.

A good technical earth system should minimize shield current. There are two fundamental approaches. In the "mesh" or reference plane approach, a large, equipotential surface or grid is developed, with pieces of the grid and surface bonded together at many points where they cross, and to earth. The shields of technical equipment and the shields of signal cables are bonded at multiple points to the reference plane/grid. In the *ideal* implementation, the reference plane would be a solid conductor of zero impedance. The solid conductive plane is, of course, practical only in a testing lab, and even then can be quite difficult, and zero impedance is not practical anywhere. The practical implementation of a mesh or reference plane typically consists of a grid of conductors at right angles to each other, bonded together at each point where they cross. All conductive objects – building structure, HVAC ducts, the raceway (trunking) system, etc. – are also bonded to the reference plane. This approximates the solid plane at frequencies below that at which the conductors that make up the mesh begin to act as anten-

nas (roughly 1/20 the wavelength of currents flowing in the plane).

The ideal **Mesh** would minimize potential differences between earthed objects at different locations by minimizing the impedance (resistance and inductance) between those points. Cable shields could, theoretically, be bonded to the reference plane at both ends, and at many points in between, because those points are (or are at least hoped to be) at equal potential. Shield current caused by potential differences is further reduced because the resistance and inductance of the shield is much greater than that of the reference plane. Signal wiring is bundled close to the reference plane, so magnetic induction is minimized because the loop area is reduced, and antenna action is minimized because the reference plane tends to “short circuit” the field.

Mesh earth systems can be quite effective in video studios, and in facilities where all signals are digital. In addition to the benefits of the earthing plane itself, the combination of hundreds of coaxial cable shields reduces the current in any one shield to a very low value. Since only one or two video signals are “on the air” at any one time, the noise added to the signal by an earth loop tends to be insignificant. Mesh earthing is successful in digital installations for a very different reason. Because the very low frequencies of power-related noise currents are so widely separated from high speed digital signals, it is quite easy to filter them out of digital equipment without degrading the digital signal.

ISOLATED GROUND SYSTEMS (THE AMERICAS)

The second fundamental approach to Technical System earthing is an **Isolated Ground System** (sometimes called a **single point** or **star** ground). An **isolated ground system** does not use a separate earth connection – the isolated ground system must be bonded to the same earth as the rest of the building. The bond is made at a single point, chosen by the system designer, (see next paragraph for details). A dedicated **isolated ground** conductor is run to every Technical system power outlet in the same conduit with the phase and neutral conductors and is connected to the **Equipment Ground (PE)** contact (the third pin) for outlets powering for technical equipment.

Ordinary outlets in the Americas have their **Equipment Ground** contacts bonded to their mounting flanges, so that installing them in a metallic backbox automatically bonds them to the backbox. That metallic box must have an **Equipment Ground** – in many jurisdictions this must be a dedicated “green” wire, while in some the electrical conductivity of the conduit system itself (trunking) can provide the **Equipment Ground**. **Isolated ground outlets** are different from standard outlets, in that their PE contact is isolated from their mounting plate, and thus from the metallic box in which they are mounted. In other words, Isolated Ground outlets simply allow the Isolated Ground wiring to run separately from the conduit (trunking) and be insulated from these multiple connections to grounded objects.

In every **Isolated Ground** system, there must be some single common point where the **Isolated Ground** is bonded to **Equipment Ground** and **System Ground**. This point is often called the **Technical Ground Common Point**. “Home” for the **isolated ground** conductors from each outlet is an **isolated ground** bus in the panel that feeds the outlet, and that bus must be connected to the **Technical Ground Common Point**. In a system small enough to be fed by a single panelboard, the **Technical Ground Common Point** may be in that panelboard, or it may be back at the **System Ground** bond. In a larger system it will nearly always be at the **System Ground** bond.

In an **Isolated Ground** system, all technical equipment must be carefully isolated from random contact with earthed objects, but it is properly earthed when its power cord is plugged into the **Isolated Ground** system. This means that all equipment, including equipment racks, must be isolated from earths, including building structure, raceway (trunking), and even concrete floors. When audio or video equipment is mounted in racks that have been carefully isolated from grounded (earthed) objects, power outlets inside those racks need not (and should not) be isolated ground outlets. The reason is simple – the racks are already isolated! It is good practice to use hospital grade outlets

throughout the system, because their contacts are built so that they show less metal fatigue, and thus maintain better contact over time.

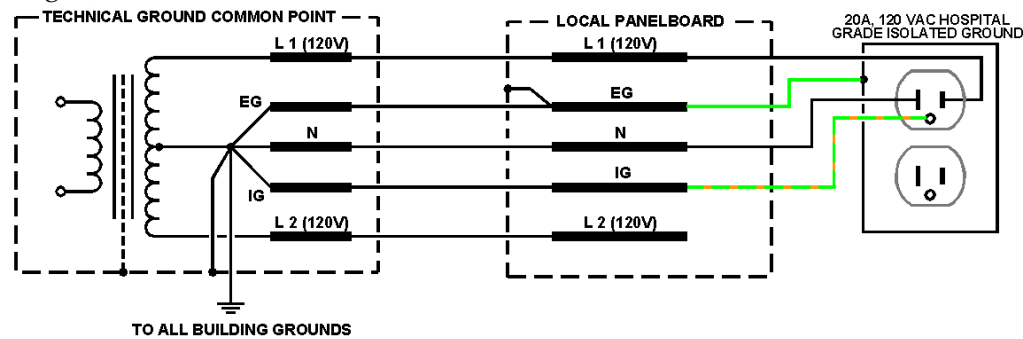

Fig 14a – A Technical Ground System Using Isolated Ground Wiring

All signal and control wiring for audio and video systems must also be isolated from ground, which means that the wiring must be isolated from the raceway system (trunking). This means that connectors mounted on conductive wiring panels around a facility must be of a type that insulate the connector shell from those panels. Plastic-body audio connectors and insulated feed-through-type BNC connectors are the weapons of choice. Special care must be taken that video cameras and projectors, antennas for wireless mic systems, and even permanently installed microphones cannot corrupt the isolated ground system. All of these devices must be isolated from random grounds, but must be grounded through the technical ground system.

Isolated ground systems minimize power-related shield current by minimizing the potential difference between the opposite ends of cable shields. The PE conductors that make up *isolated ground* system are isolated from leakage currents and potential differences between different points on building structure. Because the entire *isolated ground* system is connected to the Equipment Ground at only one point, PE conductors carry only the leakage current associated with audio/video equipment, not the much larger leakage currents produced by all other equipment in the building. Isolated Ground systems do not reduce currents from magnetic induction, nor do they help reduce RF currents on cable shields.

Isolated ground systems are widely used in the Americas for audio and video systems because they are far less costly to install than MESH systems, while providing a higher level of protection from power-related noise, and because protection from magnetic induction and RFI can be achieved by other simple techniques without the cost of a MESH system.

There is no need for an Isolated Ground system in facilities where mains power outlets are not connected to earthed objects at multiple points. Many residential structures in North America are of wood frame construction and wired without metallic conduit (trunking). Outlets are wired using three-conductor cables that carry phase, neutral, and *equipment ground* (PE). Many homes and facilities in Europe are wired in the same fashion – metallic conduit (trunking) is virtually unknown in Europe. It is also common for Isolated Ground systems in the Americas to be isolated beginning at a sub-panel from which audio/video outlets are fed, but not isolated "upstream" (that is, closer to the power source) from that panel. All of these installation types are isolated ground systems by the American definition, even though they use ordinary outlets. All carry the earth connection from some central distribution panel to every outlet in the system, using PE conductors equal to or larger than the current-carrying conductors, and following the same path.

Isolated Ground wiring inside equipment racks requires standard outlets, bonded to the rack. Isolated Ground outlets should not be used inside racks, because the rack itself must be isolated. This is the answer to the often asked question, "Why doesn't rack-mounted equipment like power conditioners and power switching units use isolated ground outlets?" The Isolated Ground conductor is bonded to a heavy copper ground

bus, which is itself bonded to the rack at multiple points.

Equipment inside the rack should be bonded to the rack (see Fig 14b). This improves shielding of the equipment, and reduces potential differences between equipment within the rack. Bonding can be improved by scraping paint adjacent to mounting screws. Equipment should also be bonded to the copper bus.

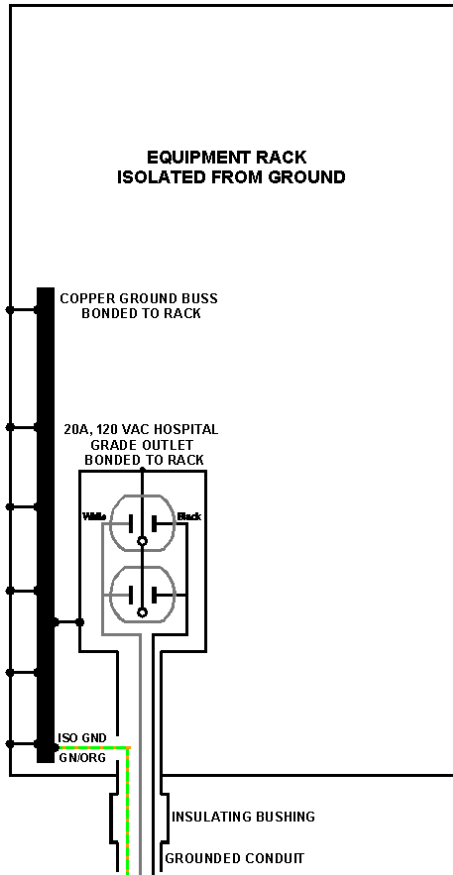

Fig 14b – Equipment Rack Wiring

Fig 14a and 14b illustrates typical implementation of a Technical Ground system using a star-connected isolated ground system. An isolation transformer establishes a separately derived 120V/240V system at the location at the left. The neutral of the separately derived system is bonded to the enclosure and to all building grounds at this location, which becomes the Technical Ground Common Point. The system feeds one or more local panelboards, which in turn feed isolated ground outlets throughout the facility. If other panelboards are needed, they would be fed from the panel at left, and wired in the same manner as the first panel. Some jurisdictions permit conduit to be used as the Equipment Ground, with no dedicated green wire. Green is the standard color for the Equipment Ground. When there is a second ground conductor (that is, an isolated ground), the second conductor must be green with an orange stripe.

Equipment Racks in Isolated Ground Systems must be isolated from ground. The rack must then be bonded to the Isolated Ground system. This typically requires the use of insulating fittings to isolate the rack from conduit, and neoprene pads to isolate it from a concrete floor or metal deck.

BREAKER PANELS AND OUTLET WIRING

In most countries, power is fed to a breaker panel (panelboard) that distributes the power to multiple branch circuits, each typically dedicated to a part of the building or to various functional systems within the building. In larger buildings, there may be several breaker panels, also dedicated to parts of the building or to functional systems. In the Americas, for example, it is common for a large audio and audio/video system to have its own breaker panel, and for that panel to feed only Isolated Ground Outlets used by that system.

In the UK, a very different "round robin" wiring scheme (called a "ring main") is used, whereby all outlets are fed in a continuous loop around each floor of a building by phase, neutral, and PE conductors that begin at the breaker panel and return to the breaker panel. The breaker panel has its own 30A fuse or 32A breaker, and the plug for every appliance has its own internal fuse (13A is standard, but lower current rated fuses may be used to protect more sensitive equipment). A building may have multiple rings, depending on its size and layout. Spurs from a loop are permitted, and may be fused or unused. If fused, they are fused at 13A.

POLARISATION OF MAINS WIRING

Installed power sockets and mating plugs in most countries are designed so that the

three-contact plugs required for Class I equipment can only be inserted one way – that is, the hot (phase) conductor for the equipment always connects to the hot (phase) conductor at the plug, and the neutral in the plug always mates with the neutral in the socket. The Schuko plug and socket used in most of Europe is an exception – the plug and socket are completely symmetrical, so they can mate "reversed" – that is, neutral mated with hot, and hot mated with neutral. This standard explains why virtually no European equipment would ever make the mistake of bonding neutral to its PE conductor – doing so would cause a fuse to blow if it were plugged in backwards! Another result of the lack of polarisation is that appliances must switch both sides of mains power to make certain that neither side of the power circuit remains energized when power is off. Few products do switch both sides of the line. This is a shortcoming of non-polarised mains wiring.

In many countries, Class II equipment uses 2-circuit plugs that mate only with phase and neutral, and can be inserted normally or reversed. The most common Class II plug in Europe, called the Europlug, mates with nearly all power sockets in Europe (except those in the UK), and can be inserted in either direction. The plugs and sockets used in the Americas are polarized because the phase (hot) blade and receptacle socket shorter than the neutral blade. In most countries with cultural ties to America or the UK, both Class I and Class II plugs are polarized.

BALANCED POWER

Balanced power is often touted as the ultimate cure for hum and buzz in project studios. The reality is that it can offer no more than 6-10 dB of reduction in hum and buzz coupled into audio and video systems. How and why do these systems work? The answer is found in Figures 15 and 16. The power supplies in most audio and video gear have capacitance between each side of the power line and its enclosure. C1 and C2 are stray capacitance between the power transformer primary winding, its frame, and its secondary. Frame and/or secondary are usually bonded to the equipment enclosure. They are shown here as grayed-out, dashed lines, because you won't find them on the schematic, but they are a byproduct of the physical construction of the transformer, and they are quite real. C3 and C4 are part of EMC filters that are built into most equipment to prevent the transmission of RF noise into and out of equipment via the power line.

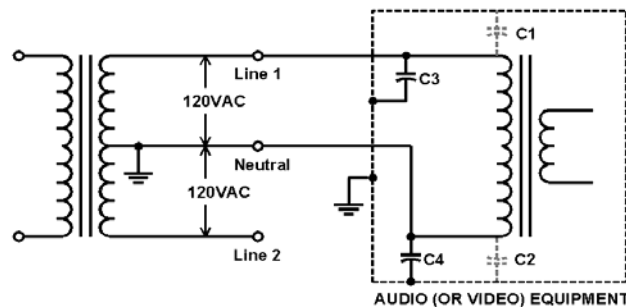

Fig 15 –A Conventional Un-Balanced Power System

In a conventional power system, shown in Fig 15, C1 and C3 have the full line voltage across them, and provide a path for a small leakage current from the power line to the equipment ground. 100 ma of leakage current is quite common, and this current will couple power line hum and buzz onto the equipment ground by virtue of the IR drop. C2 and C4 are between the neutral (grounded conductor) and the Equipment Ground, so carry little if any current.

In a balanced power system, shown in Fig 16, a transformer with a center-tapped 120 VAC secondary has its neutral bonded to the equipment ground, to produce 60 VAC to ground from both sides of the line. This places equal voltages across C1, C2, C3, and C4. IF (C1+C3) were precisely equal to (C2+C4), the leakage currents would cancel to zero. In reality, C3 and C4 are of approximately equal value, while C1 is usually approx-

ciably larger than C2. As a result, there is only modest cancellation between the current from the two legs. Reductions on the order of 8-10 dB are typical. This reduction in noise voltage on the equipment ground translates directly into reduced noise current on audio and video system wiring.

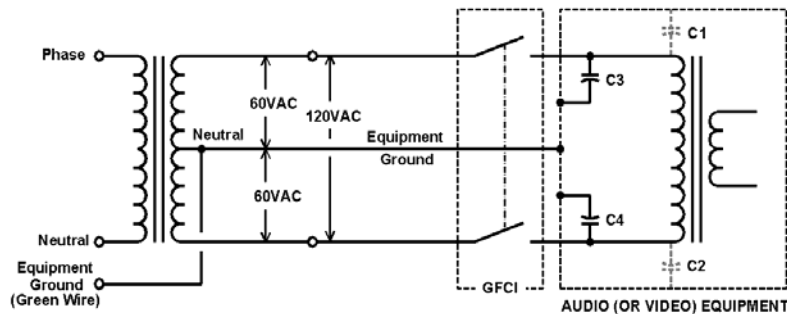

Fig 16 –A Balanced Power System per NEC 647 (2002)

How does a balanced power system reduce system noise?

1. Reduced shield current causes an equal reduction in the IR (and IZ) voltage drop along the shield. In unbalanced systems, any voltage drop on the shield is in series with the signal, so a 10 dB reduction in shield current will reduce noise by 10 dB. In balanced systems, it will reduce the need for high CMRR by 10 dB.
2. Shield current flows into pin 1. In equipment that has a pin 1 problem, any shield current will be heard as noise. Again, a 10 dB reduction in shield current reduces noise by 10 dB.
3. Shield current causes noise to be introduced onto the signal pair by SCIN (shield-current-induced noise). SCIN won't couple enough 60 Hz and 180 Hz to be heard, but it's far more likely that any high frequency noise that may be shorted to the enclosure by those capacitors will be audible.

NEC 647, which defines the requirements for balanced power systems, places some important restrictions on both their installation and use.

1. Conductors must be sized so that the voltage drop does not exceed 1% of the line voltage under a load equal to 50% of the branch circuit current rating, and so that the combined voltage drop of the feeders and the branch circuit wiring does not exceed 2%.
2. A dedicated **Equipment Ground** conductor must be run to all equipment and each receptacle.
3. All receptacles must be protected by a GFCI.
4. The neutral must be bonded per NEC 250, and must also be connected to the grounded conductor of the circuit that feeds the system.
5. Balanced power systems are restricted to industrial and commercial occupancies.
6. All outlets "shall have a unique configuration" and must be identified using specific language called out in NEC 647.7.
7. There must be a receptacle having a grounded circuit conductor (i.e., conventional unbalanced power) within 6 ft of each receptacle for the balanced power system.
8. All lighting fixtures connected to balanced power must be specifically rated for 60/120 VAC balanced power, must "have a disconnecting means that interrupts all ungrounded conductors," and must be permanently installed.
9. Isolated ground receptacles are permitted.

Balanced power systems are expensive, and their noise reduction capability is limited to about 10 dB. Isolated ground systems and/or local bonding are generally far more effective and much less costly solutions.

IDEAL POWER AND GROUND SYSTEM ARCHITECTURE FOR AUDIO/VIDEO SYSTEMS

In the Americas, the ideal power system architecture for audio and video systems is a separately derived 240/120 VAC single phase system shown in Figure 14a. The transformer that derives the system should be a high quality isolation transformer with two Faraday shields, and the transformer should be located such that the system can be bonded to a good earth ground by means of a very short conductor. A star-connected isolated ground system is the most practical technical ground system for most audio and video systems.

If touring sound systems will be used in an American facility, a separately derived 120/208 VAC 3-phase system as shown in Figure 3 should feed a disconnect switch at a suitable location on stage. If there will be occasion for use of a recording or broadcast truck, a second disconnect switch powered from either the same or an additional 3-phase system should be located near where the truck can be parked. The isolated ground bus should be extended to both of these locations.

Each outlet for audio and video systems should have its own dedicated phase, neutral, and isolated ground conductors home run to the panel from which it is fed. Wiring that is shared between outlets provides a common impedance by which noise can be coupled from one piece of equipment to another. Using individual conductors for each outlet also minimizes voltage drops under load, improving regulation.

In countries where all equipment runs on 220V – 240V, a single phase system fed by an isolation transformer of suitable size should be sufficient for all but the largest facilities.

UNBALANCED AUDIO AND VIDEO CONNECTIONS

In our study of leakage currents, we learned that the voltage drop from these currents often causes the chassis of each piece of equipment to be a few mV different from each other, and higher leakage voltages are not uncommon. The signal return (shield/screen) of unbalanced connections must be connected to the shielding enclosure at both ends, and the signal reference must be connected to the enclosure and the PE, so any voltage difference between the two PE conductors is in series with the signal, and is added to the signal. Mesh bonding and Isolated Ground systems are two methods of minimizing that voltage difference for systems that extend throughout a building. **Local Bonding** can be an effective method for systems confined to a very small area, like a mix position or small control room. **Local Bonding** can also be used to improve the noise immunity of **Isolated Ground** and **Mesh-** systems.

LOCAL BONDING (FOR EQUIPMENT IN VERY CLOSE PROXIMITY)

With local bonding, 1) all equipment is plugged into outlets that share the same **Green Wire (PE conductor)**, or to outlets whose **PE** conductors are bonded together by one or more conductors having very low resistance; and 2) the enclosures of all equipment are bonded together by conductors having very low resistance. Step #1 takes the IR (voltage) drop in the long Green Wire (PE) between the outlet and the panel out of the circuit, so that the only IR drops are in the short line cords between the equipment and the outlet. Step #2 shorts out the much smaller IR drops that remain between the connected equipment.

Consider, for example, a typical mix position for a live event. The mix desk and effects rack should be plugged into a single bank of mains power outlets that have their PE conductors bonded together, all equipment in the rack should be plugged into a strip or bank of outlets within the rack whose PE conductors are bonded together, all equipment in the rack is bonded to the rack rails, and a short, heavy gauge copper braid

bonds the rack to the enclosure of the mix desk.

For local bonding to work, the resistance of the bonding path must be very small. Bonding conductors must be heavy gauge copper, and they must be short. The noise voltage is proportional to the resistance, so reducing the resistance by half reduces the noise by 6dB (two conductors in parallel, or half the conductor length, or 12 dB if you do both). For lengths of a meter or less, #10 (2,6 mm) copper may be sufficient, but two parallel #10 (2,6 mm diameter) conductors or a single #7 (3,7 mm) would be 6dB better. Don't make the bonding conductors any longer than necessary – doubling the length adds 6dB of buzz!

Within racks, make sure that paint on equipment doesn't prevent good contact with mounting rails. Steel racks are strongly preferred, both because they act as a conductor having a large cross sectional area (and thus a low resistance), and also because they provide shielding.

Local bonding only works locally – local bonding at the mix position won't prevent noise coupled by leakage current on feeds to an amplifier rack at the stage, or from direct connections to musical instrument amplifiers. Local bonding in a video production rack prevents unbalanced interconnect noise within the rack, but it won't prevent noise coupled via leakage current from a remotely located projector or camera. Local bonding won't work with equipment that is widely separated (more than a few meters) because bonding is made less effective by the increased resistance of longer bonding conductors. This limitation can be overcome for separations of 3m or so (10 ft) by bonding with multiple copper conductors in parallel, but the copper needed to make local bonding work over long distances is both expensive and bulky, so the point of diminishing returns is quickly reached.

PREVENTING MAGNETIC COUPLING – SHIELDING, TWISTING, CONDUIT SPACING

There are four basic techniques by which magnetic coupling between power circuits and audio/video systems can be avoided, and the beneficial effects of each are cumulative. They are:

- ♦ Increase spacing between the noise source and the A/V system and its wiring.
- ♦ Run the wiring for the noise source and wiring for the A/V system at right angles to each other. Magnetic coupling is multiplied by the cosine of the angle between the wiring – it will be greatest when the runs are in parallel, and least when the runs are at right angles.
- ♦ Run the phase and neutral conductors for each power circuit as twisted pairs within their conduit so that the radiated magnetic field cancels. Additional magnetic field rejection will be achieved if audio circuits are twisted pairs.
- ♦ Shield either or both systems with steel. Feeders and branch circuit wiring is most effectively shielded by enclosing it in rigid steel conduit – approximately 30 dB at power frequencies – or roughly 15 dB if in EMT (Steel Electrical Metallic Tubing) conduit. The shielding these conduits provide is additive – if both power and signal wiring are in EMT, a total of 30 dB of shielding will exist between the two types of wiring. Aluminum and PVC conduit should be avoided - - aluminum conduit provides only electric field shielding, and PVC conduit provides no shielding at all.

Magnetic fields are produced by current, not voltage. For the same power level, equipment operating from 220-240V systems uses half as much current as the same equipment operating from 100-120V systems. Magnetic coupling is also proportional to frequency. Thus, for equivalent equipment and wiring, 230V 50 Hz systems, by their nature, produce 7.5 dB less magnetic interference than 120V 60 Hz systems.

CONDUIT (TRUNKING) IN NORTH AMERICA

Conduit is widely used in North America to protect both mains power wiring and signal

wiring. The most common forms of conduit are, in order of greatest effectiveness:

- 1) **Rigid steel** A relatively heavy gauge of galvanized steel with threaded ends to facilitate joining. This conduit provides the highest degree of magnetic shielding and physical protection for the wiring. The conduit size identifies the inner diameter, and the wall thickness varies, increasing with increasing diameter. A special variant of rigid steel conduit has a waterproof coating to minimize oxidation when it is buried in earth.
- 2) **Intermediate metal conduit (IMC).** A somewhat lighter gauge of galvanized steel.
- 3) **Electrical metallic tubing** (also called "thin wall", or *EMT*) A much lighter gauge of galvanized steel, smaller diameters can be readily bent to form curves. EMT is the most widely used form of metallic conduit. It provides roughly one half the magnetic shielding (in dB) as compared to Rigid Steel conduit.
- 4) **Aluminum conduit.** Not widely used (thankfully, because it provides no magnetic shielding).
- 5) **PVC conduit** Provides no shielding at all, only mechanical protection. PVC conduit is becoming increasingly more common because it is cheap, and because those who install it have been paid and don't stick around to experience the problems caused by lack of shielding.

Conduit is sold in 10 ft lengths (about 3m), with inner diameters of 1/2-inch, 3/4-inch, 1-inch, 1.25-inch, 1.5-inch, 2-inch, 3-inch, and 4-inch. PVC conduit, rigid steel, and IMC cannot be bent, so electrical supply stores sell pre-formed 90-degree elbows. PVC conduit is joined with glue; metallic conduits are joined with fittings that use compression clamps and screws. Conduits are joined directly, and in junction boxes and at electrical panels. In a good installation, the conduit system will be continuous, completely containing all permanent wiring. Conduit and fittings are relatively cheap, but the labor to install it is not, and more labor is required to install heavier conduit.

NORTH AMERICAN PRACTICE FOR SEPARATION OF WIRING

For reasons of safety, American building codes (NEC) generally prohibit signal wiring and power wiring from sharing the same conduit (trunking). Separation also can minimize the coupling of power-related noise into audio and video systems.

If conduits are relatively widely spaced, audio/video system signal wiring and power wiring for branch circuits can be in EMT conduit. Power feeders should always be in rigid steel conduit. If conduits must be very closely spaced, branch circuits or audio/video signal wiring, or both should be in rigid steel. Table 1 provides suggested minimum spacing between audio/video system conduits and conduits carrying power wiring. Ampacities are for the combination of all phase conductors in the power conduits. NO indicates that the use should be avoided. Spacings assume that power conductors will not be twisted pairs. Closer spacings can be used if power conductors are twisted pairs.

Audio/Video Conduit	Power Conduit	15 A	30 A	60 A	120 A	240 A	400 A
EMT	EMT	1 ft	2 ft	3 ft	4 ft	NO	NO
EMT	Rigid	2 in	4 in	8 in	1 ft	2 ft	4 ft
Rigid	Rigid	0.5 in	1 in	2 in	4 in	8 in	16 in

Table 1

Large transformers and motors produce strong magnetic fields that can be picked up and amplified by A/V system equipment and wiring. No large power transformers or motors should be located within 50 feet of recording or broadcast studios, stages, worship platforms, control rooms, A/V equipment rooms, or sound control positions. Where this limit must be stretched because of building layouts, we offer these guidelines.

In order of significance in terms of **interference production**, rated beginning with most significant, are:

- Transformers and large motors
- Switchboards, panels and feeders
- Branch circuits.

In terms of A/V systems **receiving interference**, the most sensitive elements, in order beginning with most sensitive are:

- Areas where microphones and guitars will be used
- Mix locations where audio will be present as an analog signal, including sound control rooms
- Mic wiring
- Video monitors and projectors that use CRT displays
- Equipment racks

Table 2 lists suggested minimum spacings between power conduits and locations where audio/video equipment is installed or will be used. Ampacities are for the combination of all phase conductors in the power conduits. Spacings assume that power conductors will not be twisted pairs. Much closer spacings can be used if power conductors are twisted pairs. The “pull path” is the path that portable cables (audio snakes, video wiring, etc.) takes from a stage to an audience mix location or a broadcast truck.

Mains Power Conduit -- Location	Under 60A	60 A	120 A	240 A	400 A
EMT - Control Room	ok	1 ft	30 in	5 ft	10 ft
Rigid Steel - Control Room	ok	ok	ok	2 ft	5 ft
EMT - House Mix/Pull Path	ok	2 ft	4 ft	8 ft	16 ft
Rigid Steel - House Mix/Pull Path	ok	6 in	1 ft	2 ft	4 ft
EMT - Platform, Pit	ok	2 ft	4 ft	8 ft	16 ft
Rigid Steel - Platform, Pit	ok	ok	1 ft	2 ft	4 ft
EMT - Equipment Rooms	ok	1 ft	30 in	5 ft	10 ft
Rigid Steel - Equipment Rooms	ok	ok	ok	2 ft	4 ft

Table 2

POWER FACTOR

The fundamental definition of power factor is the ratio of the real power to the product of voltage and current (volt-amperes) in a circuit. Until recently, sinusoidal loads were assumed (that is, the current and voltage were both essentially sine waves), so engineers were taught that an alternate definition of “power factor” was the cosine of the phase angle between the current and the applied voltage. As non-linear (non-sinusoidal) loads (electronic power supplies, fluorescent lighting, etc.) have become an increasingly dominate fraction of the load in most facilities, the IEEE and IEC have modified their definition of power factor to include the highly impulsive nature of the current drawn by these devices.

power factor, displacement (A) The displacement (phase angle) component of power factor. (B) The ratio of active power of the fundamental wave, in watts, to the apparent power of the fundamental wave, in volt-amperes. This ratio is the cosine of the phase angle between the fundamental voltage and the fundamental current.

Power factor, distortion the fundamental current divided by the total r.m.s. current

Power factor, total The ratio of the total power input, in watts, to the total volt-ampere input. The total power factor (PF) is now the displacement PF x the distortion PF.

POWER QUALITY

In an ideal world, the voltage on the mains power lines would be constant, but the real world is far from ideal. Power can be “non-ideal” in several ways.

1. Poor regulation i.e., under-voltage or over-voltage. The basic causes are 1) overloading of the power grid, causing utilities to reduce voltage, and 2) voltage drops in distribution lines under heavy loading. A Backup Power Supply (BPS) is designed to take over when the voltage drops below a certain level, and many BPS units have voltage regulation capability.
2. Intermittent loss of power – i.e. drop-outs. These can be as short as a fraction of a second and as long as hours or days.

[Note: Backup Power Supplies are often (incorrectly) called Uninterruptible Power Supplies (UPS). The two are very different. A UPS is always operating, converting AC to DC to charge a battery, the battery continuously powering an inverter that regenerates AC to power the equipment. A BPS is normally in standby mode, and operates only in case low voltage or power failure. See the discussion of UPS.

3. High voltage transients – i.e., spikes or surges. The most common causes of transients are 1) lightning; and 2) inductive current being switched at some remote location (typically a motor or generator). These transients can be anything from a few volts to several thousand volts, and typically last for a few seconds or less.
4. The displacement power factor (the cosine of the phase angle between the current and the voltage in a power system) may be low. For a load that is essentially sinusoidal (motors, heating elements excited at the power frequency, incandescent lighting operating at the power frequency), real power delivered is equal to the voltage multiplied by the current multiplied by the power factor. When the power factor is much less than one, the current required to provide a given amount of power will be much higher than if the voltage and current were in phase. The primary cause of a low displacement power factor is the presence of highly inductive loads (primarily motors, but also the magnetizing and leakage inductances of large transformers).

The principal concerns with a low displacement power factor are that 1) the power company must deliver more current for a given amount of power, and 2) that current causes increased heating in wiring, connectors, transformers, and generators. Displacement power factor is generally not a major concern with audio and video systems.

5. As noted in the discussion of harmonic current, current is drawn by the power supplies of electronic equipment in relatively short pulses, but those pulses can be of relatively high amplitude. The voltage drops produced by the resistance and inductance of the branch circuit conductors when these pulse currents flow will be superimposed on the supply voltage. For example, a power supply specified to draw an average current of 1A might draw its current in the form of pulses that lasts for only 10% of the positive half cycle and 10% of the negative half-cycle, but with a peak amplitude of 12A. If the impedance (resistive and inductive) between the power source and the load were 0.6 ohm (the resistance of 100 ft of #14-2), the line to neutral voltage would sag by $(12 * 1.414 * 0.6)$ volts = 10 volts at the peak of that current pulse, the peak to peak value of the noise would be 10 volts, and it would consist of harmonics of the mains frequency, 50 or 60 Hz! Not only that, but the RMS value of the current could be nearly double the average value.
6. Radio frequency noise may be coupled onto the power line (or onto the equipment ground) by switch-mode power supplies, especially those that are poorly designed. This noise can cause serious interference to radio reception (AM and FM broadcast tuners, wireless mic receivers, hearing impaired systems). If this noise is impressed onto cable shields, it could couple into signal circuits by the mechanisms of pin 1 problems, SCIN and capacitance imbalance in balanced circuits, and IZ drops on the shield of unbalanced wiring. Power supplies and

battery chargers for large consumer and commercial equipment such as power tools, electric blankets, low-voltage lighting, golf carts, etc. are notorious sources of RF noise. Ironically, this noise is coupled onto equipment grounds by the capacitors within line filters that most national governments require to be built into electronic equipment!

Fig 17 shows the spectra of audio frequency noise current on the shield of wiring connected between equipment at widely separated locations. The large peaks at the left are the 60 Hz fundamental and low order harmonics. Components above 100 kHz are likely to be noise from switching power supplies, and some of those above 500 kHz may be AM broadcast stations. Components between about 1 kHz and 100 kHz are likely to be noise from various motors, fields radiated by CRT monitors, and switching noise from a wide variety of other equipment. The noise spectra extends well above the 20kHz limit of this sweep.

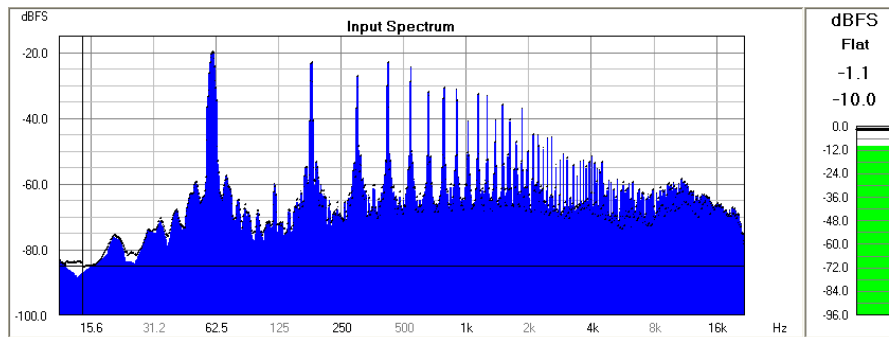

Fig 17 – Typical noise spectra on a equipment ground

SURGE SUPPRESSION

Traditionally, facilities and equipment have been protected from power line transients by shunting them to “ground,” simply because that was the only method available. [In electrical terms, a low resistance circuit element connected in parallel with another device is called a “shunt,” and is intended to short out or divert current away from that device. For example, a small capacitor across a signal circuit or power circuit shorts out RF signals so that the protected equipment does not see the RF.] This is called “shunt-mode” suppression, and the shunt device most commonly used is a Metal Oxide Varistor (MOV).

MOVs have at least three serious shortcomings as protection devices. 1) They fail, often without warning, and often destructively. Once they have failed, they provide no protection. 2) MOVs have a finite life, and their ability to shunt the surge to ground degrades over time, also without warning. Again, they provide little or no protection in this condition. 3) An MOV connected between line (phase) and equipment ground pollutes the ground with the surge voltage. Low surge voltages couple noise to the ground, which can often enter the audio or video system by causing shield current to flow. Very powerful spikes (lightning hits, very large voltage spikes produced by major power faults) can raise the ground voltage enough to cause destructive failure of system equipment connected anywhere in the building.

Series-mode surge suppression operates very differently, storing the surge energy in an inductor and slowly discharging it back into the power line from whence it came. High quality series-mode surge suppressors overcome all of the limitations of shunt-mode devices – they do not have finite lifetimes, their performance does not degrade with time, and they do not pollute the ground (that is, they don’t couple noise to ground, and they don’t cause the surge to blow up other equipment). Series-mode suppressors currently have only one important limitation – it is practical to build them only large enough to protect branch circuits.

BONDING SHUNT MODE PROTECTORS

Shunt mode devices can cause damage to equipment if, during a surge event (lightning, power transient) they conduct the surge to the ground conductor at some point other than the building common point. When that happens, the ground conductor takes the full weight of the surge, and thanks to resistance and inductance in the ground conductor(s), the voltage rises to a very high value. If that ground conductor is connected to other equipment (for example, by the shield of an audio or video cable), or even capacity-coupled by means of an Ethernet cable connecting two pieces of equipment, it is very likely that one or both pieces of equipment will fail destructively, because the other equipment is bonded to ground at a different point in the building. In other words, it is the difference in the voltage between the two pieces of interconnected equipment that causes the failure. To avoid this failure mode, shunt mode suppressors must be bonded to a ground only to the building common point.

Shunt-mode devices must still be used when protection is needed at the building service entrance, on system feeders, and on most forms of signal wiring (antennas, telephone lines, audio lines). They can be used safely at the service entrance because in a properly bonded installation, this point is the common point for all earth connections within the building, so during a surge event, if the shunt device returns to the ground common point for the building, the ground voltage for the entire building rises to about the same level, so interconnected equipment does not see the strike voltage. ***The only good (safe for equipment) place to install shunt mode devices is at the building's ground point.***

DEALING WITH ANTENNAS

Many installations include some form of outdoor receiving antenna, including satellite downlinks and cable TV down-leads. Three key issues must be addressed.

- 1) **Lightning Protection** For lightning safety, these cables must be grounded (earthed) via the shortest practical path to the common point for all earth connections within the building. This path should be outside the building, and routed to the audio/video system in a manner that any lightning energy is far more likely to take the intended path to earth rather than go to earth through the audio/video system or cause mischief elsewhere in the building. A suitable lightning protection device should also be installed in series with the coaxial cable to protect the input stage of the receiving equipment. Polyphaser, Industrial Communications Engineers, and Nextek are manufacturers of such devices in North America. [Indoor antennas, like those used for wireless mics and computer networking are an exception – they do not require a connection to ground, and should generally be isolated from ground.]
- 2) **Good RF performance** The antenna must be coupled to audio/video receiving equipment in a manner that does not create excessive loss.
- 3) **Prevent Earth Loops** The cable shield should be broken by some form of RF transformer before the input to the receiving equipment (but not between the antenna and the connection of the lightning protection device to earth). Excellent isolation transformers are available from Jensen Transformers.



Fig 18 – RF Surge Suppressors for use on receiving antennas

A form of shunt mode protector called a Gas Discharge Tube, or GDT is the preferred protection device for most signal wiring, like antennas, telephone lines, audio circuits,

and video circuits. Like any other shunt mode device, suppressors using GDTs that protect balanced circuits must be installed very close to the common point for all earth connections within the building, and must have a very low impedance bond to that point at the frequency of lightning. GDTs can also protect coaxial inputs and outputs of equipment by wiring them in parallel with the signal path. Fig 19 shows three shunt-mode protectors designed to protect receiving antennas. Although they are shunt-mode devices (GDTs), RF protectors are packaged with input and output connectors, built so that the transmission line impedance is maintained through the protector, and so that the protector enclosure can be bonded to a ground bus. The Nextek unit (left) is the most flexible – it passes RF signals from 0 to 2.5 GHz at up to 25 watts, and up to 3A DC at up to 48V to power an outdoor preamp – and it is also the least expensive. It is designed to mount as a "feed-through" connector on a metal plate.

The shield (screen) connection of the GDT must be bonded to the system ground common point. The GDT protects the electronics from the differential voltage on the coax, and the bond to the ground system provides the discharge path for lightning on the shield (screen).

POWER CONDITIONING

Power conditioning is a rather broad term, describing processes to correct one or more of the problems noted above. In its broadest meaning, it connotes voltage regulation to correct for the line voltage being higher or lower than normal, surge suppression to eliminate short term faults that can damage equipment, and bandpass filtering to reduce noise. Some may even attempt to reduce harmonic currents. Unfortunately, much of the equipment sold in the name of power conditioning does more to relieve purchasers of their money than to improve power quality.

ISOLATION TRANSFORMERS

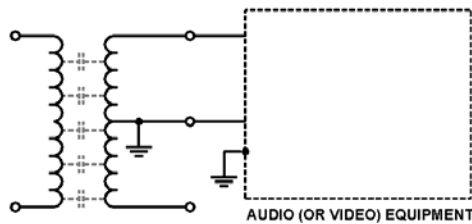

Figure 19a – An Ordinary Transformer

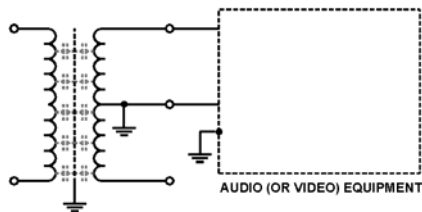

Figure 19b – An Isolation Transformer

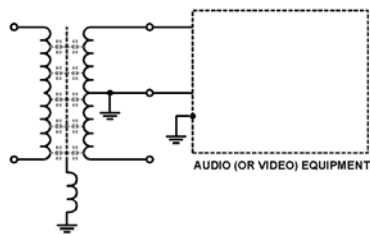

Figure 19c – Isolation Transformer showing inductance of earthing path

Common mode noise on the power line can be coupled into audio equipment via the power supply. In an ordinary transformer, shown schematically in Fig 19a, stray capacitance between the primary and secondary windings will couple high frequency energy across the transformer – the higher the frequency, the greater the coupling. At low frequencies, where the capacitance is too small to provide much coupling, the transformer blocks common mode noise.

A Faraday shield, shown schematically in Fig 19b, can be added to a transformer, and can greatly reduce coupling by shorting high frequency energy to earth. A Faraday shield is simply a conductive barrier placed between the two windings. Fig 19c, and the equivalent circuit in Fig 19d, however, shows that the shield works by forming a voltage divider between primary and secondary. But it also shows that the attenuation will be limited by the impedance between the

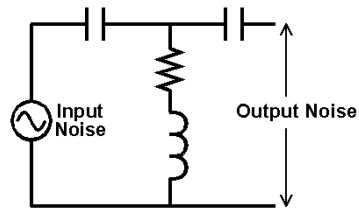

Figure 19d- Equivalent circuit

losses, ordinary power transformers tend to provide differential-mode low pass filtering to block noise.

Note that an isolation transformer does not isolate earths between primary and secondary if building codes require that all earths within a building be bonded together (and North American codes do). Isolation transformers can provide effective reduction of noise on the power line, but they must be installed in a manner that minimizes R and L in the earthing path if they are to be of any value. If the inductance and resistance of the earth lead are large, the isolation transformer will provide little if any noise reduction.

At trade shows, misguided (unscrupulous?) salesmen often demonstrate their expensive isolation transformers by showing a scope connected between neutral and the equipment ground with and without the isolation transformer in use. Without the transformer, there is noise between the neutral and the equipment ground due to normal current flow on both conductors. With the transformer installed, the scope probe, still connected between neutral and ground, is shorted out by the bond between neutral and ground, so "that awful power line noise" seems to be killed by the transformer. But that noise is not a fundamental cause of problems in equipment – no reasonable power supply should pass power line noise to signal circuitry! More important, a properly installed isolation transformer does reduce to change noise current on the equipment ground (and may even increase it), and noise on the equipment ground is a primary cause of noise in audio and video systems! For more on these noise coupling mechanisms see the discussions of unbalanced wiring and pin 1 problems.

UNINTERRUPTIBLE POWER SOURCES (UPS)

Uninterruptible and Backup Power Supplies protect equipment from short term power failures. As long as there is mains power, an Uninterruptible Power Supply continuously produces DC to keep a battery safely charged and simultaneously uses that DC to power an inverter that regenerates the AC mains power (usually, but not necessarily 120VAC) needed by the protected equipment. When power fails, regeneration continues until the battery is discharged. The batteries may be completely internal to the unit, or external to the unit, or a combination of both. The greater the battery capacity, the longer the protected equipment can run in the event of a power failure. Ideally the regenerated voltage would be a sine wave; in reality, the voltage may be only a first approximation of a true sine wave.

BACKUP POWER SUPPLIES

Backup Power Supplies are often mistakenly called Uninterruptible Power Supplies (UPS), a mistake begun and perpetuated by those selling them. Unlike a BPS, which stands by idle until the power fails, an Uninterruptible Power Supply is always charging its battery, and the battery is always providing power to the equipment it protects. UPS units are much more expensive to manufacture than BPS units because they must run continuously – they require more highly rated components and greater cooling. A BPS (or a UPS) large enough to run an entire sound system would be very large and very expensive.]

Nearly all products sold as an Uninterruptible Power Supply (UPS) are actually Backup Power Supplies. The "weasel words" include "off-line UPS" a "switching UPS," or a "standby" UPS. A BPS unit also has a standby battery (usually a much smaller one than

Faraday shield and earth. We learned in our discussion of the connection of systems to earth that this impedance consists mostly of the inductive reactance of the earth connection, along with a smaller (usually) resistive component.

Thanks to their built-in stray inductance, capacitance, and high frequency

a UPS), monitors the power line to make sure that mains power is present and within tolerance, and keeps the standby battery fully charged. When mains power is “good,” the protected equipment operates directly from mains power. If power is interrupted, the BPS quickly goes into action, using the battery as a source of power to regenerate the AC line voltage, and switching the protected equipment from the power line to the regenerated source. And just like the UPS, batteries may be internal, external, or both, and backup operating time depends on battery capacity and condition.

A UPS always operates as a separately derived source, and by its nature, provides a high degree of isolation from line noise and transients (but because its neutral and equipment ground must be bonded to the same ground as the rest of the power system, it provides no help with noise on the equipment ground). A UPS also functions as a voltage regulator – as long as there is sufficient line voltage to operate the AC to DC to AC conversion process and the load current stays within limits, the output voltage is essentially held constant. A BPS is a separately derived system only when it is regenerating power, and only then does it provide isolation from the power line noise and transients. Many modern BPS units include a clever voltage regulator circuit that switches a “boost-buck” transformer in and out of the circuit if the mains voltage exceeds or falls below a specified tolerance (usually 5%).

Boost-buck transformers are power transformers (often auto-transformers) with a relatively high stepdown ratio. The primary is connected across the power line, and the secondary is connected in series with the load either in polarity (boost mode) or out of polarity (buck mode). For example, a boost/buck transformer with a turns ratio of 10:1 would provide 12 volts on the secondary from a 120 VAC source. If added to the source when the line voltage drops to 105 volts, it would bring the load voltage back up to 115.5 volts; if subtracted from the line voltage when it rose to 132 volts, it would bring the load voltage down to 119 volts. A boost/buck transformer with 12:1 and 24:1 taps on the secondary could be switched to hold the load voltage within about 4 volts. Boost/buck transformers can be relatively small, because they must provide only a small fraction of the total power in the circuit in which they are used (1/10 in the example). The secondary, of course, must be rated for the full load current, but for less than 10% of the load voltage.

Virtually all modern UPS and BPS units include conventional shunt-mode surge suppression using MOVs. For this reason, there should **always** be a series mode surge suppression unit between the UPS or BPS and the power line. The reason is simple – we don’t want the MOV to pollute the equipment ground with noise transients, and we don’t want the MOV to dump a lightning strike or other destructive spike onto the equipment ground where it can blow up other equipment whose signal wiring may be connected to that equipment ground.

GROUND FAULT CIRCUIT INTERRUPTERS AND RESIDUAL CURRENT DEVICES

People are vulnerable to electric shock when leakage current flows through their body to another earthed object. Excessive leakage current could cause the external enclosure of equipment to be “above ground” by enough voltage to cause a dangerous shock if a person touched the defective equipment with one hand and another ground (a water pipe, for example) with the other hand. [We tend to think of excessive leakage current as being generated by defective equipment, but it can also be generated by perfectly normal line filter capacitors (and transformer stray capacitances) in multiple pieces of equipment connected to same Equipment Ground point.]

American power systems must include a Ground Fault Circuit Interrupter (GFCI or GFI) at locations where people are likely to come in contact with both electrical equipment and an earth connection (for example, outdoors and around plumbing). In European power systems, the same function is provided by a single Residual Current Detector (RCD) located in the breaker panel. The purpose of GFCIs and RCDs is to protect people from electrical shock due to excessive leakage currents or other faults. The NEC also requires GFCIs protect all receptacles in balanced power systems.

GFCIs and RCDs are devices that sense very small values of leakage current, and interrupts the circuit if leakage exceeds the defined limit. They work by detecting the difference between the current on the “hot” or “phase” conductor and the current on the Neutral. If there is no leakage current, the hot and neutral current should be equal. Any difference between these two currents must be flowing to earth. NEC requires that GFCI devices trip if the imbalance (leakage current) exceeds about 6 mA. The RCDs used in Europe to protect all the outlets in a building are set to trip at about 30mA. Typically the panelboard will be divided into two sections. One, which feeds outlets throughout the building, is protected by the RCD. The other section, which feeds critical functions where the likelihood of electrical shock is low (for example, lighting, refrigeration) is not RCD-protected.

Some Useful Troubleshooting Tools

Troubleshooting power and earthing problems essentially boils down to finding and eliminating magnetic fields and potential differences between shield connection points at the opposite ends of audio and video system wiring. If systems are wired properly, magnetic fields should be contained between the parallel conductors of power system wiring, and within the cores of transformers and motors. Likewise, a properly installed and earthed electrical system without faults should set up relatively small potential differences between earthed objects. Here are some useful tools.

One of the most common wiring errors is a neutral that is earthed (grounded) at more than one point. The neutral for the building service must be earthed at the service entrance. Each separately derived system (i.e., the secondary of a stepdown or isolation transformer) must be earthed at the transformer. That’s all! Suspect this problem if, when using the troubleshooting tools listed below, you find strong magnetic fields at 50/60 Hz and harmonics of 50/60 Hz. An additional bond between **Neutral** and **Equipment Ground (PE)** causes return current to divide between **Neutral** and the **PE**, which in turn causes the magnetic field to escape from its confinement between **Phase** (hot) and **Neutral** conductors to create a strong hum field with a large loop area.

Another common wiring error is an unintended connection of an **Isolated Ground** bus to a building ground. This can happen when a piece of equipment plugged into an IG outlet is in contact with some randomly grounded object – the building structure, a catwalk, an HVAC duct, a grounded antenna lead-in. Such a connection will defeat the IG system because it establishes a path for shield current. To find this sort of error, have an electrician shut down power to the panel feeding the system and temporarily disconnect the bond between the IG bus and the building ground. An ohmmeter can then be used to find any improper ground(s), checking each conductor tied to that bus one at a time.

OUTLET TESTERS

Outlet testers are an extremely valuable tool. People who wire electrical systems make mistakes, and it is common for there to be wiring errors in power systems. Some errors merely add hum, buzz, and noise to the audio system, while others can damage equipment or even kill people. A skilled technician could drag an array of test equipment around a facility and test each outlet under load to find those mistakes, but testing each outlet would consume considerable field labor. Low cost outlet testers (selling for about \$30) check only for basic wiring errors. More expensive units (typically about \$300) also test for excessive IR drop under load on all three conductors and for proper operation of a GFCI, and do it all in a few seconds.

Ideal makes both types of products for American wiring. Charvin-Arnoux, Fluke, and Metrix make quality products for European wiring. One of the better American units is the Inspector II, manufactured by Tasco, Inc. of Englewood, CO. Older products made by Tasco, and by Ecos, (long out of business, but available on the used market) are also very good. It is well worth searching out one of the Tasco or Ecos units.

One of the most problematic wiring errors, and also the most difficult to detect, is the

exchange of *Neutral* and *Equipment Ground (PE)*. This error causes the full load current to flow on the *Equipment Ground* rather than the *Neutral*. This establishes a current loop with a very large loop area, which can result in very strong magnetic coupling of hum and buzz into signal circuits. A magnetic field probe may be the most effective way to expose this sort of error (see below).

MAGNETIC FIELD PROBE

Effective probes for audio-frequency magnetic fields can be made from a CRT degaussing coil (the kind that used to be sold for use in a TV service shop), or from a good dynamic microphone that has no hum-bucking coil and relatively little magnetic shielding (an EV 635A, for example), or even a telephone pickup coil from Radio Shack. Simply connect the probe to the input of a battery-powered microphone preamp that can drive headphones, and walk around listening for the fields (the mic will also have acoustic pickup that you must teach your brain to ignore). A user receiver for an inductive loop hearing impaired system is also a convenient and inexpensive probe if it doesn't have high pass filtering to reject hum.

CLAMP-ON AMMETER AND PROBE



Fig 20 – Current probes and breakout cable

Clamp-on ammeters are large coils that are designed to couple to a voltmeter or oscilloscope. The most useful ones have more turns and can sense relatively small currents, and can be connected to a scope or RTA. Fluke and AEMC make very good ones in a wide range of sensitivities. Avoid units designed to measure very large currents and choose one that can measure small currents (10mA – 100 mA).

A current probe measures the sum of the currents in the conductors it surrounds. A probe surrounding all three conductors (phase, neutral, and equipment ground) would not see the load current. The orange cable in the photo is a commercial product with its insulation stripped away so that a current probe can measure the current in each conductor.

You can also make your own current probe for shield current by interrupting one end and inserting a small value resistor (less than 1 ohm). Connect an AC voltmeter, headphone amplifier, scope, or audio spectrum analyzer across the resistor. [Any electronic device used to measure this voltage must be battery powered – a device connected to mains power would produce invalid results.] Use Ohm's law with the voltmeter or scope to find the current. Another good method is to measure the voltage between the chassis of a piece of equipment and the PE conductor at the outlet, find the resistance of the wire by consulting wire tables, and apply Ohm's Law to that voltage and resistance. In North America, most IEC line cords have AWG#18 conductors (6.4 Ω /1,000 ft, 21 Ω /km). A very few are built with AWG #14 (2.5 Ω /1,000 ft, 8.3 Ω /km) or #16 (4 Ω /1,000 ft, 13.2 Ω /km).

AUDIO VOLTMETER

A simple audio voltmeter, scope, or headphone amplifier connected between the ends of a cable is a very unreliable method of measuring magnetically induced voltage because its leads disturb the current loop (that is, change the loop area).

SCOPE, AUDIO SPECTRUM ANALYZER

These instruments are most useful for tracking down power and earthing problems if they are battery powered. Use them to analyze the output of a current or magnetic

probe, or connect them between the ends of the cable. Mains powered instrumentation can be used if the test leads are isolated a high quality audio transformer with dual Faraday shields. The Jensen Iso-Max PB2-XX is a good choice.

THE JARGON

Building codes are filled with “jargon,” and safety regulations like the National Electrical Code are no exception. As with many legal documents, the use of certain words within the document carry a special meaning beyond a dictionary definition or even standard usage.

Bonding – the permanent joining of metallic parts to form an electrically conductive path that will insure continuity and the capacity to conduct any current likely to be imposed.

Bonding jumper – A reliable conductor used to ensure the required electrical conductivity between metal parts required to be electrically connected.

Main bonding jumper – The connection between the **grounded circuit (neutral)** and the **equipment grounding buss** at the service.

Branch circuit – all wiring between the last means of disconnection (the breaker panel or fuse box) and the load (outlets).

Feeders – all wiring between the service and the last means of disconnection (i.e., circuit breaker or fuse) before power outlets.

Equipment – material, fittings, appliances, raceway, conduit, fixtures, and apparatus.

Equipment ground (Protective Earth, PE) – A conductor that bonds together the enclosures of all equipment connected to the power line (mains power). The primary function of this conductor is to protect life and property in the case of a fault by providing a solid path for current that will blow a fuse or trip a breaker in the case of a fault.

Fault – A failure of the electrical system, or of something connected to it, that causes an unsafe condition. Typical faults are an electrical short circuit, equipment failure, the connection of improperly wired equipment or of equipment that draws more current than the circuit can deliver without overheating, a wiring error, or a lightning strike.

Grounding electrode – the conductor that makes contact with the earth.

Load equipment – equipment that draws power from the electrical system.

Load current – current from mains power flowing in a loop that includes the phase (hot, line) conductor, the equipment, and the neutral.

Means of disconnection – a circuit breaker or fuse that causes power to be removed from a circuit in the case of a fault.

Solidly grounded – the neutral and earth ground electrodes are directly connected with no impedance (intentionally) placed between them. Thus the word **solid** implies a d.c. connection -- i.e. nothing more than a short wire.

Phase conductor – the **ungrounded** (hot) power conductor.

Neutral – the **grounded conductor**. (The white wire in North America, blue in Europe).

Outlets – connected equipment or receptacles.

Panel – an electrical enclosure.

Panelboard – an electrical enclosure with circuit breakers.

Service, service entrance – the connection of a building or other facility to the power company’s wiring.

Separately derived source – a separate power source that is not directly connected to the power company’s transformer – for example, the secondary of a transformer or the

output of a generator.

Authority Having Jurisdiction: The local government agency having legal authority for establishing building codes and verifying compliance.

Safety Agency (UL, ETL, CSA): An independent testing body, not affiliated with government, whose business is to test the safety of equipment, fittings, and hardware in their intended use. The focus of these agencies is the protection of life and property. They are not concerned with the effectiveness of equipment, except to the extent that it relates to these safety issues. These agencies test products primarily 1) to make sure that it will not start a fire; 2) that it will not contribute to flame spread; 3) that it will not create noxious fumes when it burns; and 4) that it will not create a shock hazard.

Listed – Equipment, fittings, and hardware that is recognized by the Authority Having Jurisdiction (AHJ) as acceptable for use in electrical systems. Most AHJs in North America require that all elements of electrical systems be listed (including most installed audio and video systems), and delegate responsibility for listing and testing for listing to a safety agency such as Underwriter's Laboratories (UL), Canadian Safety Agency (CSA), and Electrical Testing Laboratories (ETL).

REFERENCES AND RECOMMENDED READING

OTT, HENRY W., *Electromagnetic Compatibility Engineering*, Wiley Interscience, 2009 – An absolutely essential book. Henry Ott nailed it, in this definitive text that ties together both theory and practice in EMC. If you disagree with a single word in this book, you're wrong! This is a significant update and expansion of *Noise Reduction Techniques in Electronic Systems*, Wiley Interscience, Second Edition, 1988, which has been the standard for two decades. Ott doesn't "hide behind the math," including just enough to allow solid numbers to be assigned to each mechanism that affects EMC.

MUNCY, NEIL. A. "Noise Susceptibility in Analog and Digital Signal Processing Systems," J. Audio Eng. Soc., vol 43, pp. 435-453 (1995 June) The paper that introduced both SCIN and the Pin 1 problem. A classic!

WHITLOCK, BILL "Balanced lines in Audio Systems: Fact, Fiction, and Transformers," J. Audio Eng. Soc., vol 43, pp. 454-464 (1995 June) How balanced audio circuits really work.

BROWN, JIM and WHITLOCK, BILL, "Common-Mode to Differential-Mode Conversion in Shielded Twisted-Pair Cables (Shield-Current-Induced Noise)," AES Preprint 5747, Presented at 114th AES Convention, Amsterdam, 2003 March This paper adds to the understanding of SCIN, proves that SCIN is active well into the MHz region, and shows that SCIN is a major contributor to RFI from AM broadcast and ham transmitters.

GIDDINGS, PHIL, *Audio Systems Design and Installation*, Focal Press, 1990. An excellent reference for power and grounding. Some of the material on balanced signal wiring is wrong. Study Whitlock instead.

MORRISON, RALPH, AND LEWIS, WARREN; *Grounding and Shielding in Facilities*, Wiley Interscience, 1990 Especially helpful in describing standard practice in power and grounding, and also with deciphering jargon. The authors are staunch advocates of MESH grounding for technical systems, but their focus is primarily industrial and data centers – audio systems are barely on their radar.

IEEE Recommended Practice for Powering and Grounding Electronic Equipment (IEEE Emerald Book), IEEE Std 1100-1999, Institute of Electrical and Electronic Engineers, Inc., New York. 1999

IEEE Recommended Practice for Grounding of Commercial Power Systems and Equipment (IEEE Green Book), IEEE Std 142-1991, Institute of Electrical and Electronic Engineers, Inc., New York. 1991

NEC 2005 Handbook National Fire Protection Association, Quincy, MA 2005 The Code by itself is deadly dry, full of jargon, and hard to read. Buy the Handbook version,

which helps a lot. Both are revised every three years.

Comprehensive Dictionary of Electrical Engineering Terms P. Laplante, Editor; CRC Press, 1999 A useful reference when you run into jargon.

The ARRL Handbook American Radio Relay League, Inc. Newington, CT Published annually. More engineers have learned electricity, electronics, and radio from “The Handbook” than from all other sources combined! Very readable, solid science, minimal math.

Electric Current Abroad US Department of Commerce 1992 <http://www.ita.doc.gov/media/Publications/pdf/current2002FINAL.pdf> Lists the voltages, frequency, and type of plug used in most countries of the world.

Electricity Around the World <http://users.telenet.be/worldstandards/electricity.htm> Begins with the same information as the US Dept of Commerce publication, but much better photos of the plugs, maps showing which countries use which systems and plugs, and a great deal more useful text about usage of plugs and which are able to mate with sockets in each country. This page is available in French and Dutch.

ACKNOWLEDGEMENTS

This first version of this applications note was commissioned by New Frontier Electronics (the SurgeX people), who wanted “something to pass out to contractors who didn’t quite understand technical power and grounding,” and wanted to know “why isolated ground outlets aren’t needed inside racks.” I suspect they got far more than they bargained for. The section on balanced power is based on analysis by Bill Whitlock. Dale Svetanoff (WA9ENA) and Tom Rauch (W8JI) contributed solid thoughts on lightning protection and RF grounding issues. Neil Muncy, Bruce Olson, Pat Brown, and Dale Shirk reviewed the manuscript and offered useful comments. As always, I thank them for their good counsel and encouragement. Neil also shared some of his troubleshooting techniques.

For the latest edition, John Woodgate, Ben Kok, Nick Salis, and Peter Patrick have helped the author with details of practice in Europe, the UK, and Australia.

The author, and our entire industry, are greatly indebted to Henry Ott, whose excellent workshop on EMC I attended in 2004, and whose book, cited above, should be on everyone’s shelf. It would be difficult to conceive of an issue related to EMC that Henry hasn’t thought through in great detail, considering every possible ramification, from the micro to the macro, and from circuit performance to manufacturability to user-friendliness to where things will be in 20 years. A side-comment in his book (first published in 1976, updated in 1988 and again in 2009) makes it clear that he knew about SCIN at least 20 years ago.

Appendix – European and North American Systems Compared

Courtesy John Woodgate

Divided by a common language The words used for this subject differ on the two sides of the Atlantic, and some of them are used quite vaguely, to mean different things in different contexts. So, here is a short guide to the words.

British English	US English
Earth	Ground
Line or Phase conductor (brown)	Line or phase conductor (black)
Neutral conductor (blue)	Neutral or grounded conductor (white)
Protective (earth) conductor (green and yellow)	Grounding conductor (green)
Screen, screening	Shield, shielding
Mains lead	Power cord
Trunking	Raceway

There are also some words in use that should not be, because they are vague or misleading or both, and we need to look at those:

Signal-earth (or signal-ground): the better term is '*signal common*'.

Chassis-earth (or chassis-ground): the better term is '*enclosure*', assuming it is electrically conducting. If it isn't, the concept doesn't really exist.

POWER SYSTEM ARCHITECTURES IN EUROPE AND THE AMERICAS

Five different systems are used for the distribution of electric power in public 'low voltage' systems, and these may also be used in private systems. These systems differ primarily in how they treat the **grounded conductor (neutral)** and its relationship to the **Protective Earth (PE) conductor**. ('*Low voltage*' in this context means, in practice, systems with phase voltages between 100 V and 240 V.)

In all but one variant of one system, something in the system is connected to the planet by means of a buried electrode. This allows earthed equi-potential bonding to be used as a protection against electric shock as described in the main portion of this tutorial. In the naming convention, T indicates Three-phase, N indicates that there is a Neutral from the power company, C indicates that Neutral and PE are combined in the feed from the power company, S means that neutral and PE are separated, either in the feed from the power company or within the building.

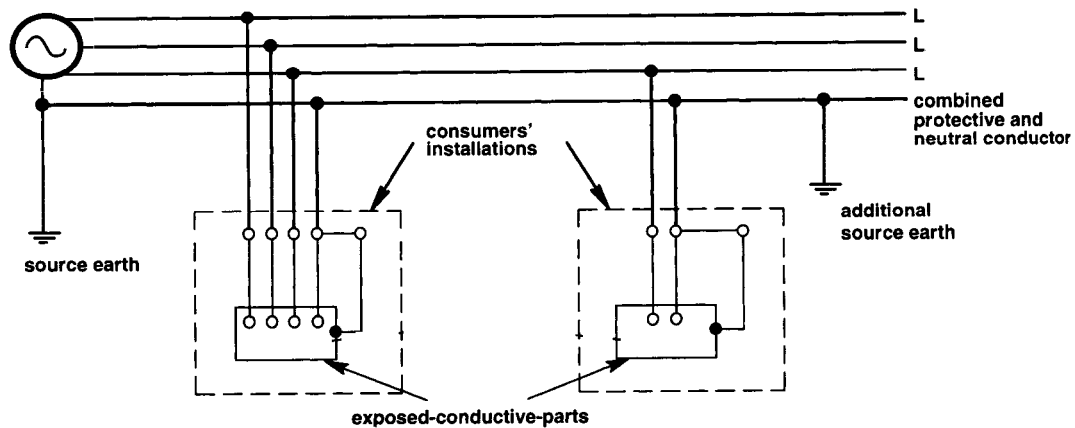

Fig A-1 – TN-C-S (PME) system

TN-C-S system: Both TN-C and TN-S configurations are used in different parts of the system. This configuration is also known as '*Protective Multiple Earthing*' (*PME*). (Figure A-1) The TN-C-S system is the most common system worldwide, used in the Americas,

most of Europe, and in part of the United Kingdom. In the Americas and continental Europe, the bond between neutral and earth is made at the service entrance. In the United Kingdom, the bond between neutral and earth is made only at the power utility. Inside the building, **Neutral** and **PE (Equipment Ground)** are carried separately to all equipment and outlets. In most countries, an earth electrode is bonded to the PE at the point where power enters the premises (the **service entrance**).

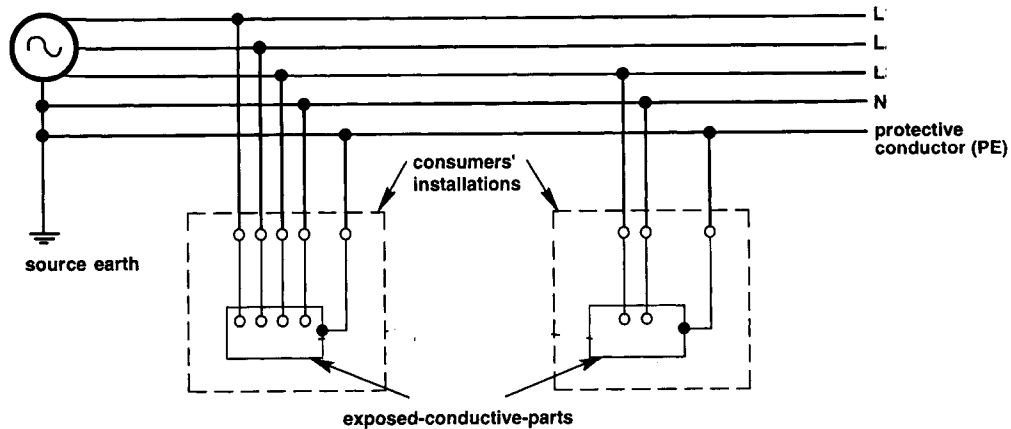

Fig A-2 – TN-S system

TN-S system: One pole of the supply system is connected to one or more electrodes buried in the ground. This pole is connected to the neutral conductor of the distribution cables, and also connected to a protective conductor in the distribution cables, which is used to 'earth' exposed conductive parts of a load installation. The neutral and protective conductors are insulated from each other in the distribution network and in load installations. (Figure A-2)

The TN-S system is one of two systems used in the United Kingdom (the other is the TN-C-S system). The bond between the Neutral and Earth occurs only at the power utility (that is, within power company equipment). In the UK, if a local earth electrode is used, it must be connected to the PE conductor where power enters the premises (the **service entrance**).

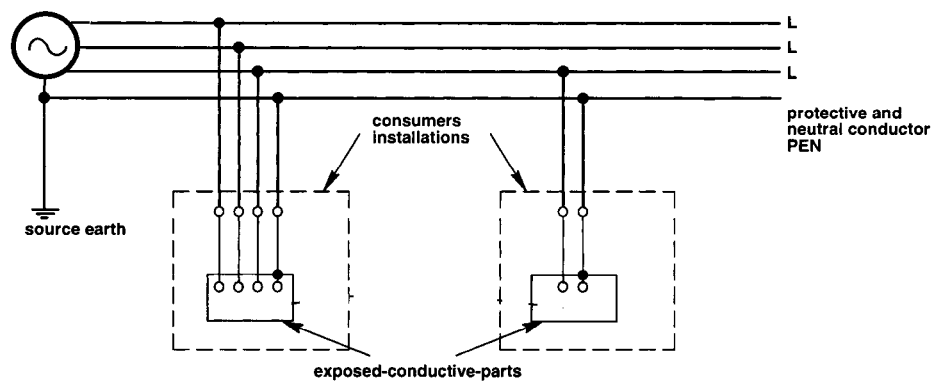

Fig A-3 – TN-C system

TN-C system: One pole of the supply system is connected to one or more electrodes buried in the ground. This pole is also connected to the neutral conductor of the distribution cables, which is also used to 'earth' exposed conductive parts of a load installation. (Figure A-3)

TT system: One pole of the supply system is connected to one or more electrodes buried in the ground. Local buried electrodes are used to 'earth' exposed conductive parts

of a load installation. (Figure A-4)

The TT system is a rather dangerous system, since it offers no protection against electrical shock if a fault occurs within equipment. It is dangerous because fault current through the earth is unlikely to be strong enough to cause a protective device (circuit breaker, fuse) to disconnect the power before a person might die from an electrical shock.

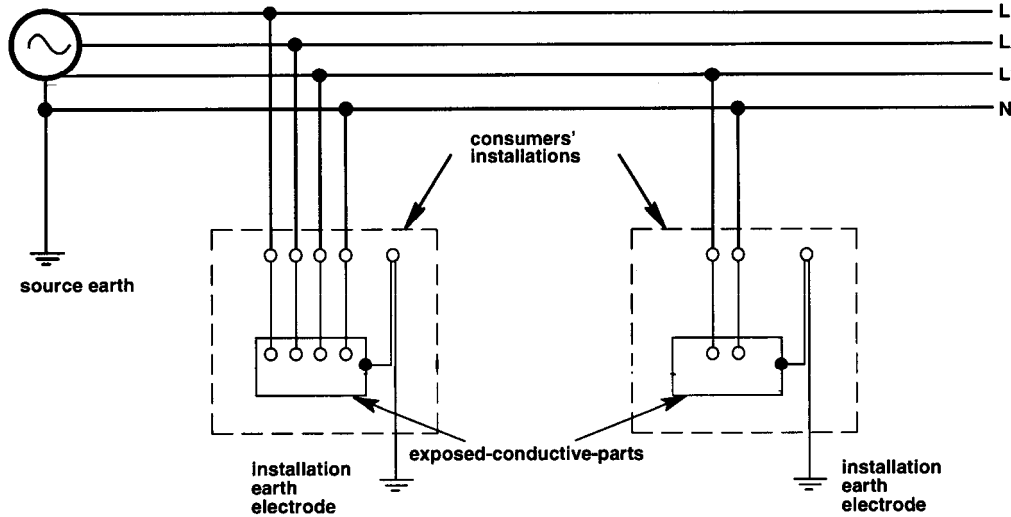

Fig A-4 – TT system

IT system: One pole of the supply system is connected through an impedance to a buried electrode. Local buried electrodes are used to 'earth' exposed conductive parts of a load installation. (Figure A-5)

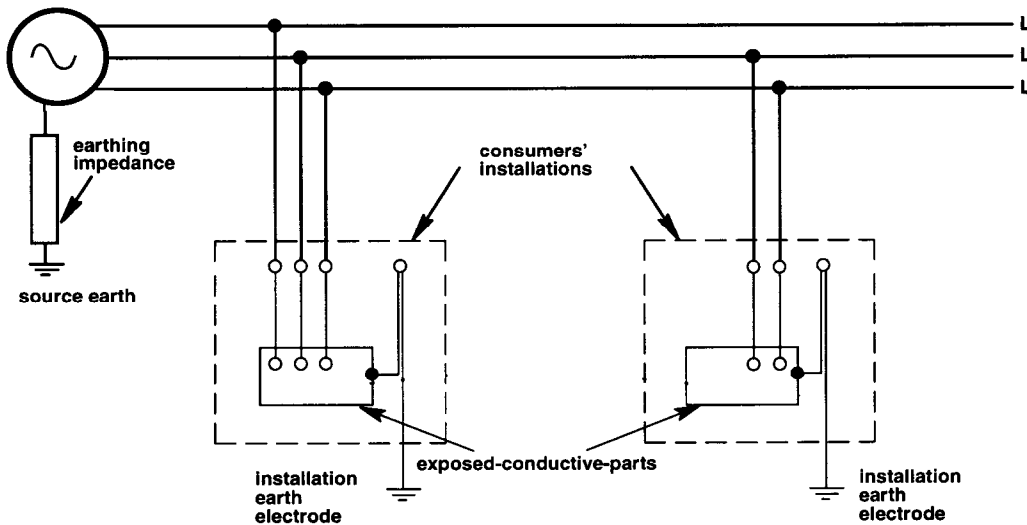

Fig A-5 – IT system

NOTE - Another variant of the IT system, used in hospitals for example, has no connection of any part of the supply system to a buried electrode. This is because patients may be connected to mains-powered equipment via invasive electrodes, bypassing the partial insulation normally provided by the skin. Consequently, leakage currents from the mains supply must be kept to an absolute minimum, even though the actual voltage of the patient with respect to any 'earth' may be unknown. Special measures have to be taken to discharge any common-mode charge built up on the supply system.